

# Operating Manual



## Universal Power Sensor

**R&S® NRP-Z11**  
1138.3004.02/.04

**R&S® NRP-Z61**  
1171.7505.02

**R&S® NRP-Z21**  
1137.6000.02

**R&S® NRP-Z211**  
1417.0409.02

**R&S® NRP-Z31**  
1169.2400.02

**R&S® NRP-Z221**  
1417.0309.02

**R&S® NRP-Z41**  
1171.8801.02

**Dear Customer,**

R&S® is a registered trademark of Rohde & Schwarz GmbH & Co. KG  
Trade names are trademarks of the owners.

# Basic Safety Instructions

## Always read through and comply with the following safety instructions!

All plants and locations of the Rohde & Schwarz group of companies make every effort to keep the safety standards of our products up to date and to offer our customers the highest possible degree of safety. Our products and the auxiliary equipment they require are designed, built and tested in accordance with the safety standards that apply in each case. Compliance with these standards is continuously monitored by our quality assurance system. The product described here has been designed, built and tested in accordance with the EC Certificate of Conformity and has left the manufacturer's plant in a condition fully complying with safety standards. To maintain this condition and to ensure safe operation, you must observe all instructions and warnings provided in this manual. If you have any questions regarding these safety instructions, the Rohde & Schwarz group of companies will be happy to answer them.



Furthermore, it is your responsibility to use the product in an appropriate manner. This product is designed for use solely in industrial and laboratory environments or, if expressly permitted, also in the field and must not be used in any way that may cause personal injury or property damage. You are responsible if the product is used for any purpose other than its designated purpose or in disregard of the manufacturer's instructions. The manufacturer shall assume no responsibility for such use of the product.

The product is used for its designated purpose if it is used in accordance with its product documentation and within its performance limits (see data sheet, documentation, the following safety instructions). Using the product requires technical skills and, in some cases, a basic knowledge of English. It is therefore essential that only skilled and specialized staff or thoroughly trained personnel with the required skills be allowed to use the product. If personal safety gear is required for using Rohde & Schwarz products, this will be indicated at the appropriate place in the product documentation. Keep the basic safety instructions and the product documentation in a safe place and pass them on to the subsequent users.

Observing the safety instructions will help prevent personal injury or damage of any kind caused by dangerous situations. Therefore, carefully read through and adhere to the following safety instructions before and when using the product. It is also absolutely essential to observe the additional safety instructions on personal safety, for example, that appear in relevant parts of the product documentation. In these safety instructions, the word "product" refers to all merchandise sold and distributed by the Rohde & Schwarz group of companies, including instruments, systems and all accessories. For product-specific information, see the data sheet and the product documentation.

## Safety labels on products

The following safety labels are used on products to warn against risks and dangers.

Symbol	Meaning	Symbol	Meaning
	Notice, general danger location Observe product documentation	○	ON/OFF supply voltage
	Caution when handling heavy equipment	⏻	Standby indication
	Danger of electric shock	— — —	Direct current (DC)

## Basic Safety Instructions

Symbol	Meaning	Symbol	Meaning
	Warning! Hot surface		Alternating current (AC)
	Protective conductor terminal		Direct/alternating current (DC/AC)
	Ground		Device fully protected by double (reinforced) insulation
	Ground terminal		EU labeling for batteries and accumulators For additional information, see section "Waste disposal/Environmental protection", item 1.
	Be careful when handling electrostatic sensitive devices		EU labeling for separate collection of electrical and electronic devices For additional information, see section "Waste disposal/Environmental protection", item 2.
	Warning! Laser radiation For additional information, see section "Operation", item 7.		

### Signal words and their meaning

The following signal words are used in the product documentation in order to warn the reader about risks and dangers.



Indicates a hazardous situation which, if not avoided, will result in death or serious injury.



Indicates a hazardous situation which, if not avoided, could result in death or serious injury.



Indicates a hazardous situation which, if not avoided, could result in minor or moderate injury.



Indicates information considered important, but not hazard-related, e.g. messages relating to property damage.  
In the product documentation, the word ATTENTION is used synonymously.

These signal words are in accordance with the standard definition for civil applications in the European Economic Area. Definitions that deviate from the standard definition may also exist in other economic areas or military applications. It is therefore essential to make sure that the signal words described here are always used only in connection with the related product documentation and the related product. The use of signal words in connection with unrelated products or documentation can result in misinterpretation and in personal injury or material damage.

## Basic Safety Instructions

### Operating states and operating positions

*The product may be operated only under the operating conditions and in the positions specified by the manufacturer, without the product's ventilation being obstructed. If the manufacturer's specifications are not observed, this can result in electric shock, fire and/or serious personal injury or death. Applicable local or national safety regulations and rules for the prevention of accidents must be observed in all work performed.*

1. Unless otherwise specified, the following requirements apply to Rohde & Schwarz products: predefined operating position is always with the housing floor facing down, IP protection 2X, use only indoors, max. operating altitude 2000 m above sea level, max. transport altitude 4500 m above sea level. A tolerance of  $\pm 10\%$  shall apply to the nominal voltage and  $\pm 5\%$  to the nominal frequency, overvoltage category 2, pollution severity 2.
2. Do not place the product on surfaces, vehicles, cabinets or tables that for reasons of weight or stability are unsuitable for this purpose. Always follow the manufacturer's installation instructions when installing the product and fastening it to objects or structures (e.g. walls and shelves). An installation that is not carried out as described in the product documentation could result in personal injury or even death.
3. Do not place the product on heat-generating devices such as radiators or fan heaters. The ambient temperature must not exceed the maximum temperature specified in the product documentation or in the data sheet. Product overheating can cause electric shock, fire and/or serious personal injury or even death.

### Electrical safety

*If the information on electrical safety is not observed either at all or to the extent necessary, electric shock, fire and/or serious personal injury or death may occur.*

1. Prior to switching on the product, always ensure that the nominal voltage setting on the product matches the nominal voltage of the AC supply network. If a different voltage is to be set, the power fuse of the product may have to be changed accordingly.
2. In the case of products of safety class I with movable power cord and connector, operation is permitted only on sockets with a protective conductor contact and protective conductor.
3. Intentionally breaking the protective conductor either in the feed line or in the product itself is not permitted. Doing so can result in the danger of an electric shock from the product. If extension cords or connector strips are implemented, they must be checked on a regular basis to ensure that they are safe to use.
4. If there is no power switch for disconnecting the product from the AC supply network, or if the power switch is not suitable for this purpose, use the plug of the connecting cable to disconnect the product from the AC supply network. In such cases, always ensure that the power plug is easily reachable and accessible at all times. For example, if the power plug is the disconnecting device, the length of the connecting cable must not exceed 3 m. Functional or electronic switches are not suitable for providing disconnection from the AC supply network. If products without power switches are integrated into racks or systems, the disconnecting device must be provided at the system level.
5. Never use the product if the power cable is damaged. Check the power cables on a regular basis to ensure that they are in proper operating condition. By taking appropriate safety measures and carefully laying the power cable, ensure that the cable cannot be damaged and that no one can be hurt by, for example, tripping over the cable or suffering an electric shock.

## Basic Safety Instructions

6. The product may be operated only from TN/TT supply networks fuse-protected with max. 16 A (higher fuse only after consulting with the Rohde & Schwarz group of companies).
7. Do not insert the plug into sockets that are dusty or dirty. Insert the plug firmly and all the way into the socket provided for this purpose. Otherwise, sparks that result in fire and/or injuries may occur.
8. Do not overload any sockets, extension cords or connector strips; doing so can cause fire or electric shocks.
9. For measurements in circuits with voltages  $V_{rms} > 30$  V, suitable measures (e.g. appropriate measuring equipment, fuse protection, current limiting, electrical separation, insulation) should be taken to avoid any hazards.
10. Ensure that the connections with information technology equipment, e.g. PCs or other industrial computers, comply with the IEC60950-1/EN60950-1 or IEC61010-1/EN 61010-1 standards that apply in each case.
11. Unless expressly permitted, never remove the cover or any part of the housing while the product is in operation. Doing so will expose circuits and components and can lead to injuries, fire or damage to the product.
12. If a product is to be permanently installed, the connection between the protective conductor terminal on site and the product's protective conductor must be made first before any other connection is made. The product may be installed and connected only by a licensed electrician.
13. For permanently installed equipment without built-in fuses, circuit breakers or similar protective devices, the supply circuit must be fuse-protected in such a way that anyone who has access to the product, as well as the product itself, is adequately protected from injury or damage.
14. Use suitable overvoltage protection to ensure that no overvoltage (such as that caused by a bolt of lightning) can reach the product. Otherwise, the person operating the product will be exposed to the danger of an electric shock.
15. Any object that is not designed to be placed in the openings of the housing must not be used for this purpose. Doing so can cause short circuits inside the product and/or electric shocks, fire or injuries.
16. Unless specified otherwise, products are not liquid-proof (see also section "Operating states and operating positions", item 1). Therefore, the equipment must be protected against penetration by liquids. If the necessary precautions are not taken, the user may suffer electric shock or the product itself may be damaged, which can also lead to personal injury.
17. Never use the product under conditions in which condensation has formed or can form in or on the product, e.g. if the product has been moved from a cold to a warm environment. Penetration by water increases the risk of electric shock.
18. Prior to cleaning the product, disconnect it completely from the power supply (e.g. AC supply network or battery). Use a soft, non-linting cloth to clean the product. Never use chemical cleaning agents such as alcohol, acetone or diluents for cellulose lacquers.

## Operation

1. Operating the products requires special training and intense concentration. Make sure that persons who use the products are physically, mentally and emotionally fit enough to do so; otherwise, injuries or material damage may occur. It is the responsibility of the employer/operator to select suitable personnel for operating the products.

## Basic Safety Instructions

2. Before you move or transport the product, read and observe the section titled "Transport".
3. As with all industrially manufactured goods, the use of substances that induce an allergic reaction (allergens) such as nickel cannot be generally excluded. If you develop an allergic reaction (such as a skin rash, frequent sneezing, red eyes or respiratory difficulties) when using a Rohde & Schwarz product, consult a physician immediately to determine the cause and to prevent health problems or stress.
4. Before you start processing the product mechanically and/or thermally, or before you take it apart, be sure to read and pay special attention to the section titled "Waste disposal/Environmental protection", item 1.
5. Depending on the function, certain products such as RF radio equipment can produce an elevated level of electromagnetic radiation. Considering that unborn babies require increased protection, pregnant women must be protected by appropriate measures. Persons with pacemakers may also be exposed to risks from electromagnetic radiation. The employer/operator must evaluate workplaces where there is a special risk of exposure to radiation and, if necessary, take measures to avert the potential danger.
6. Should a fire occur, the product may release hazardous substances (gases, fluids, etc.) that can cause health problems. Therefore, suitable measures must be taken, e.g. protective masks and protective clothing must be worn.
7. Laser products are given warning labels that are standardized according to their laser class. Lasers can cause biological harm due to the properties of their radiation and due to their extremely concentrated electromagnetic power. If a laser product (e.g. a CD/DVD drive) is integrated into a Rohde & Schwarz product, absolutely no other settings or functions may be used as described in the product documentation. The objective is to prevent personal injury (e.g. due to laser beams).
8. EMC classes (in line with EN 55011/CISPR 11, and analogously with EN 55022/CISPR 22, EN 55032/CISPR 32)
  - Class A equipment:  
Equipment suitable for use in all environments except residential environments and environments that are directly connected to a low-voltage supply network that supplies residential buildings  
Note: Class A equipment is intended for use in an industrial environment. This equipment may cause radio disturbances in residential environments, due to possible conducted as well as radiated disturbances. In this case, the operator may be required to take appropriate measures to eliminate these disturbances.
  - Class B equipment:  
Equipment suitable for use in residential environments and environments that are directly connected to a low-voltage supply network that supplies residential buildings

### Repair and service

1. The product may be opened only by authorized, specially trained personnel. Before any work is performed on the product or before the product is opened, it must be disconnected from the AC supply network. Otherwise, personnel will be exposed to the risk of an electric shock.

## Basic Safety Instructions

- Adjustments, replacement of parts, maintenance and repair may be performed only by electrical experts authorized by Rohde & Schwarz. Only original parts may be used for replacing parts relevant to safety (e.g. power switches, power transformers, fuses). A safety test must always be performed after parts relevant to safety have been replaced (visual inspection, protective conductor test, insulation resistance measurement, leakage current measurement, functional test). This helps ensure the continued safety of the product.

### Batteries and rechargeable batteries/cells

*If the information regarding batteries and rechargeable batteries/cells is not observed either at all or to the extent necessary, product users may be exposed to the risk of explosions, fire and/or serious personal injury, and, in some cases, death. Batteries and rechargeable batteries with alkaline electrolytes (e.g. lithium cells) must be handled in accordance with the EN 62133 standard.*

- Cells must not be taken apart or crushed.
- Cells or batteries must not be exposed to heat or fire. Storage in direct sunlight must be avoided. Keep cells and batteries clean and dry. Clean soiled connectors using a dry, clean cloth.
- Cells or batteries must not be short-circuited. Cells or batteries must not be stored in a box or in a drawer where they can short-circuit each other, or where they can be short-circuited by other conductive materials. Cells and batteries must not be removed from their original packaging until they are ready to be used.
- Cells and batteries must not be exposed to any mechanical shocks that are stronger than permitted.
- If a cell develops a leak, the fluid must not be allowed to come into contact with the skin or eyes. If contact occurs, wash the affected area with plenty of water and seek medical aid.
- Improperly replacing or charging cells or batteries that contain alkaline electrolytes (e.g. lithium cells) can cause explosions. Replace cells or batteries only with the matching Rohde & Schwarz type (see parts list) in order to ensure the safety of the product.
- Cells and batteries must be recycled and kept separate from residual waste. Rechargeable batteries and normal batteries that contain lead, mercury or cadmium are hazardous waste. Observe the national regulations regarding waste disposal and recycling.

### Transport

- The product may be very heavy. Therefore, the product must be handled with care. In some cases, the user may require a suitable means of lifting or moving the product (e.g. with a lift-truck) to avoid back or other physical injuries.
- Handles on the products are designed exclusively to enable personnel to transport the product. It is therefore not permissible to use handles to fasten the product to or on transport equipment such as cranes, fork lifts, wagons, etc. The user is responsible for securely fastening the products to or on the means of transport or lifting. Observe the safety regulations of the manufacturer of the means of transport or lifting. Noncompliance can result in personal injury or material damage.
- If you use the product in a vehicle, it is the sole responsibility of the driver to drive the vehicle safely and properly. The manufacturer assumes no responsibility for accidents or collisions. Never use the product in a moving vehicle if doing so could distract the driver of the vehicle. Adequately secure the product in the vehicle to prevent injuries or other damage in the event of an accident.



## Instrucciones de seguridad elementales

### Waste disposal/Environmental protection

1. Specially marked equipment has a battery or accumulator that must not be disposed of with unsorted municipal waste, but must be collected separately. It may only be disposed of at a suitable collection point or via a Rohde & Schwarz customer service center.
2. Waste electrical and electronic equipment must not be disposed of with unsorted municipal waste, but must be collected separately.  
Rohde & Schwarz GmbH & Co. KG has developed a disposal concept and takes full responsibility for take-back obligations and disposal obligations for manufacturers within the EU. Contact your Rohde & Schwarz customer service center for environmentally responsible disposal of the product.
3. If products or their components are mechanically and/or thermally processed in a manner that goes beyond their intended use, hazardous substances (heavy-metal dust such as lead, beryllium, nickel) may be released. For this reason, the product may only be disassembled by specially trained personnel. Improper disassembly may be hazardous to your health. National waste disposal regulations must be observed.
4. If handling the product releases hazardous substances or fuels that must be disposed of in a special way, e.g. coolants or engine oils that must be replenished regularly, the safety instructions of the manufacturer of the hazardous substances or fuels and the applicable regional waste disposal regulations must be observed. Also observe the relevant safety instructions in the product documentation. The improper disposal of hazardous substances or fuels can cause health problems and lead to environmental damage.

For additional information about environmental protection, visit the Rohde & Schwarz website.

# Instrucciones de seguridad elementales

### **¡Es imprescindible leer y cumplir las siguientes instrucciones e informaciones de seguridad!**

El principio del grupo de empresas Rohde & Schwarz consiste en tener nuestros productos siempre al día con los estándares de seguridad y de ofrecer a nuestros clientes el máximo grado de seguridad. Nuestros productos y todos los equipos adicionales son siempre fabricados y examinados según las normas de seguridad vigentes. Nuestro sistema de garantía de calidad controla constantemente que sean cumplidas estas normas. El presente producto ha sido fabricado y examinado según el certificado de conformidad de la UE y ha salido de nuestra planta en estado impecable según los estándares técnicos de seguridad. Para poder preservar este estado y garantizar un funcionamiento libre de peligros, el usuario deberá atenerse a todas las indicaciones, informaciones de seguridad y notas de alerta. El grupo de empresas Rohde & Schwarz está siempre a su disposición en caso de que tengan preguntas referentes a estas informaciones de seguridad.

Además queda en la responsabilidad del usuario utilizar el producto en la forma debida. Este producto está destinado exclusivamente al uso en la industria y el laboratorio o, si ha sido expresamente autorizado, para aplicaciones de campo y de ninguna manera deberá ser utilizado de modo que alguna persona/cosa pueda sufrir daño. El uso del producto fuera de sus fines definidos o sin tener en cuenta las instrucciones del fabricante queda en la responsabilidad del usuario. El fabricante no se hace en ninguna forma responsable de consecuencias a causa del mal uso del producto.















## Instrucciones de seguridad elementales

Se parte del uso correcto del producto para los fines definidos si el producto es utilizado conforme a las indicaciones de la correspondiente documentación del producto y dentro del margen de rendimiento definido (ver hoja de datos, documentación, informaciones de seguridad que siguen). El uso del producto hace necesarios conocimientos técnicos y ciertos conocimientos del idioma inglés. Por eso se debe tener en cuenta que el producto solo pueda ser operado por personal especializado o personas instruidas en profundidad con las capacidades correspondientes. Si fuera necesaria indumentaria de seguridad para el uso de productos de Rohde & Schwarz, encontraría la información debida en la documentación del producto en el capítulo correspondiente. Guarde bien las informaciones de seguridad elementales, así como la documentación del producto, y entréguelas a usuarios posteriores.



Tener en cuenta las informaciones de seguridad sirve para evitar en lo posible lesiones o daños por peligros de toda clase. Por eso es imprescindible leer detalladamente y comprender por completo las siguientes informaciones de seguridad antes de usar el producto, y respetarlas durante el uso del producto. Deberán tenerse en cuenta todas las demás informaciones de seguridad, como p. ej. las referentes a la protección de personas, que encontrarán en el capítulo correspondiente de la documentación del producto y que también son de obligado cumplimiento. En las presentes informaciones de seguridad se recogen todos los objetos que distribuye el grupo de empresas Rohde & Schwarz bajo la denominación de "producto", entre ellos también aparatos, instalaciones así como toda clase de accesorios. Los datos específicos del producto figuran en la hoja de datos y en la documentación del producto.

### Señalización de seguridad de los productos

Las siguientes señales de seguridad se utilizan en los productos para advertir sobre riesgos y peligros.

Símbolo	Significado	Símbolo	Significado
	Aviso: punto de peligro general Observar la documentación del producto		Tensión de alimentación de PUESTA EN MARCHA / PARADA
	Atención en el manejo de dispositivos de peso elevado		Indicación de estado de espera (standby)
	Peligro de choque eléctrico		Corriente continua (DC)
	Advertencia: superficie caliente		Corriente alterna (AC)
	Conexión a conductor de protección		Corriente continua / Corriente alterna (DC/AC)
	Conexión a tierra		El aparato está protegido en su totalidad por un aislamiento doble (reforzado)
	Conexión a masa		Distintivo de la UE para baterías y acumuladores Más información en la sección "Eliminación/protección del medio ambiente", punto 1.

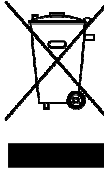
## Instrucciones de seguridad elementales

Símbolo	Significado	Símbolo	Significado
	Aviso: Cuidado en el manejo de dispositivos sensibles a la electrostática (ESD)		Distintivo de la UE para la eliminación por separado de dispositivos eléctricos y electrónicos  Más información en la sección "Eliminación/protección del medio ambiente", punto 2.
	Advertencia: rayo láser  Más información en la sección "Funcionamiento", punto 7.		

### Palabras de señal y su significado

En la documentación del producto se utilizan las siguientes palabras de señal con el fin de advertir contra riesgos y peligros.



Indica una situación de peligro que, si no se evita, causa lesiones graves o incluso la muerte.



Indica una situación de peligro que, si no se evita, puede causar lesiones graves o incluso la muerte.



Indica una situación de peligro que, si no se evita, puede causar lesiones leves o moderadas.



Indica información que se considera importante, pero no en relación con situaciones de peligro; p. ej., avisos sobre posibles daños materiales.

En la documentación del producto se emplea de forma sinónima el término CUIDADO.

Las palabras de señal corresponden a la definición habitual para aplicaciones civiles en el área económica europea. Pueden existir definiciones diferentes a esta definición en otras áreas económicas o en aplicaciones militares. Por eso se deberá tener en cuenta que las palabras de señal aquí descritas sean utilizadas siempre solamente en combinación con la correspondiente documentación del producto y solamente en combinación con el producto correspondiente. La utilización de las palabras de señal en combinación con productos o documentaciones que no les correspondan puede llevar a interpretaciones equivocadas y tener por consecuencia daños en personas u objetos.

### Estados operativos y posiciones de funcionamiento

*El producto solamente debe ser utilizado según lo indicado por el fabricante respecto a los estados operativos y posiciones de funcionamiento sin que se obstruya la ventilación. Si no se siguen las indicaciones del fabricante, pueden producirse choques eléctricos, incendios y/o lesiones graves con posible consecuencia de muerte. En todos los trabajos deberán ser tenidas en cuenta las normas nacionales y locales de seguridad del trabajo y de prevención de accidentes.*

## Instrucciones de seguridad elementales

1. Si no se convino de otra manera, es para los productos Rohde & Schwarz válido lo que sigue: como posición de funcionamiento se define por principio la posición con el suelo de la caja para abajo, modo de protección IP 2X, uso solamente en estancias interiores, utilización hasta 2000 m sobre el nivel del mar, transporte hasta 4500 m sobre el nivel del mar. Se aplicará una tolerancia de  $\pm 10\%$  sobre el voltaje nominal y de  $\pm 5\%$  sobre la frecuencia nominal. Categoría de sobrecarga eléctrica 2, índice de suciedad 2.
2. No sitúe el producto encima de superficies, vehículos, estantes o mesas, que por sus características de peso o de estabilidad no sean aptos para él. Siga siempre las instrucciones de instalación del fabricante cuando instale y asegure el producto en objetos o estructuras (p. ej. paredes y estantes). Si se realiza la instalación de modo distinto al indicado en la documentación del producto, se pueden causar lesiones o, en determinadas circunstancias, incluso la muerte.
3. No ponga el producto sobre aparatos que generen calor (p. ej. radiadores o calefactores). La temperatura ambiente no debe superar la temperatura máxima especificada en la documentación del producto o en la hoja de datos. En caso de sobrecalentamiento del producto, pueden producirse choques eléctricos, incendios y/o lesiones graves con posible consecuencia de muerte.

### Seguridad eléctrica

*Si no se siguen (o se siguen de modo insuficiente) las indicaciones del fabricante en cuanto a seguridad eléctrica, pueden producirse choques eléctricos, incendios y/o lesiones graves con posible consecuencia de muerte.*

1. Antes de la puesta en marcha del producto se deberá comprobar siempre que la tensión preseleccionada en el producto coincida con la de la red de alimentación eléctrica. Si es necesario modificar el ajuste de tensión, también se deberán cambiar en caso dado los fusibles correspondientes del producto.
2. Los productos de la clase de protección I con alimentación móvil y enchufe individual solamente podrán enchufarse a tomas de corriente con contacto de seguridad y con conductor de protección conectado.
3. Queda prohibida la interrupción intencionada del conductor de protección, tanto en la toma de corriente como en el mismo producto. La interrupción puede tener como consecuencia el riesgo de que el producto sea fuente de choques eléctricos. Si se utilizan cables alargadores o regletas de enchufe, deberá garantizarse la realización de un examen regular de los mismos en cuanto a su estado técnico de seguridad.
4. Si el producto no está equipado con un interruptor para desconectarlo de la red, o bien si el interruptor existente no resulta apropiado para la desconexión de la red, el enchufe del cable de conexión se deberá considerar como un dispositivo de desconexión. El dispositivo de desconexión se debe poder alcanzar fácilmente y debe estar siempre bien accesible. Si, p. ej., el enchufe de conexión a la red es el dispositivo de desconexión, la longitud del cable de conexión no debe superar 3 m). Los interruptores selectores o electrónicos no son aptos para el corte de la red eléctrica. Si se integran productos sin interruptor en bastidores o instalaciones, se deberá colocar el interruptor en el nivel de la instalación.
5. No utilice nunca el producto si está dañado el cable de conexión a red. Compruebe regularmente el correcto estado de los cables de conexión a red. Asegúrese, mediante las medidas de protección y de instalación adecuadas, de que el cable de conexión a red no pueda ser dañado o de que nadie pueda ser dañado por él, p. ej. al tropezar o por un choque eléctrico.

## Instrucciones de seguridad elementales

6. Solamente está permitido el funcionamiento en redes de alimentación TN/TT aseguradas con fusibles de 16 A como máximo (utilización de fusibles de mayor amperaje solo previa consulta con el grupo de empresas Rohde & Schwarz).
7. Nunca conecte el enchufe en tomas de corriente sucias o llenas de polvo. Introduzca el enchufe por completo y fuertemente en la toma de corriente. La no observación de estas medidas puede provocar chispas, fuego y/o lesiones.
8. No sobrecargue las tomas de corriente, los cables alargadores o las regletas de enchufe ya que esto podría causar fuego o choques eléctricos.
9. En las mediciones en circuitos de corriente con una tensión  $U_{\text{eff}} > 30 \text{ V}$  se deberán tomar las medidas apropiadas para impedir cualquier peligro (p. ej. medios de medición adecuados, seguros, limitación de tensión, corte protector, aislamiento etc.).
10. Para la conexión con dispositivos informáticos como un PC o un ordenador industrial, debe comprobarse que éstos cumplan los estándares IEC60950-1/EN60950-1 o IEC61010-1/EN 61010-1 válidos en cada caso.
11. A menos que esté permitido expresamente, no retire nunca la tapa ni componentes de la carcasa mientras el producto esté en servicio. Esto pone a descubierto los cables y componentes eléctricos y puede causar lesiones, fuego o daños en el producto.
12. Si un producto se instala en un lugar fijo, se deberá primero conectar el conductor de protección fijo con el conductor de protección del producto antes de hacer cualquier otra conexión. La instalación y la conexión deberán ser efectuadas por un electricista especializado.
13. En el caso de dispositivos fijos que no estén provistos de fusibles, interruptor automático ni otros mecanismos de seguridad similares, el circuito de alimentación debe estar protegido de modo que todas las personas que puedan acceder al producto, así como el producto mismo, estén a salvo de posibles daños.
14. Todo producto debe estar protegido contra sobretensión (debida p. ej. a una caída del rayo) mediante los correspondientes sistemas de protección. Si no, el personal que lo utilice quedará expuesto al peligro de choque eléctrico.
15. No debe introducirse en los orificios de la caja del aparato ningún objeto que no esté destinado a ello. Esto puede producir cortocircuitos en el producto y/o puede causar choques eléctricos, fuego o lesiones.
16. Salvo indicación contraria, los productos no están impermeabilizados (ver también el capítulo "Estados operativos y posiciones de funcionamiento", punto 1). Por eso es necesario tomar las medidas necesarias para evitar la entrada de líquidos. En caso contrario, existe peligro de choque eléctrico para el usuario o de daños en el producto, que también pueden redundar en peligro para las personas.
17. No utilice el producto en condiciones en las que pueda producirse o ya se hayan producido condensaciones sobre el producto o en el interior de éste, como p. ej. al desplazarlo de un lugar frío a otro caliente. La entrada de agua aumenta el riesgo de choque eléctrico.
18. Antes de la limpieza, desconecte por completo el producto de la alimentación de tensión (p. ej. red de alimentación o batería). Realice la limpieza de los aparatos con un paño suave, que no se deshilache. No utilice bajo ningún concepto productos de limpieza químicos como alcohol, acetona o diluyentes para lacas nitrocelulósicas.

## Instrucciones de seguridad elementales

### Funcionamiento

1. El uso del producto requiere instrucciones especiales y una alta concentración durante el manejo. Debe asegurarse que las personas que manejen el producto estén a la altura de los requerimientos necesarios en cuanto a aptitudes físicas, psíquicas y emocionales, ya que de otra manera no se pueden excluir lesiones o daños de objetos. El empresario u operador es responsable de seleccionar el personal usuario apto para el manejo del producto.
2. Antes de desplazar o transportar el producto, lea y tenga en cuenta el capítulo "Transporte".
3. Como con todo producto de fabricación industrial no puede quedar excluida en general la posibilidad de que se produzcan alergias provocadas por algunos materiales empleados —los llamados alérgenos (p. ej. el níquel)—. Si durante el manejo de productos Rohde & Schwarz se producen reacciones alérgicas, como p. ej. irritaciones cutáneas, estornudos continuos, enrojecimiento de la conjuntiva o dificultades respiratorias, debe avisarse inmediatamente a un médico para investigar las causas y evitar cualquier molestia o daño a la salud.
4. Antes de la manipulación mecánica y/o térmica o el desmontaje del producto, debe tenerse en cuenta imprescindiblemente el capítulo "Eliminación/protección del medio ambiente", punto 1.
5. Ciertos productos, como p. ej. las instalaciones de radiocomunicación RF, pueden a causa de su función natural, emitir una radiación electromagnética aumentada. Deben tomarse todas las medidas necesarias para la protección de las mujeres embarazadas. También las personas con marcapasos pueden correr peligro a causa de la radiación electromagnética. El empresario/operador tiene la obligación de evaluar y señalizar las áreas de trabajo en las que exista un riesgo elevado de exposición a radiaciones.
6. Tenga en cuenta que en caso de incendio pueden desprenderse del producto sustancias tóxicas (gases, líquidos etc.) que pueden generar daños a la salud. Por eso, en caso de incendio deben usarse medidas adecuadas, como p. ej. máscaras antigás e indumentaria de protección.
7. Los productos con láser están provistos de indicaciones de advertencia normalizadas en función de la clase de láser del que se trate. Los rayos láser pueden provocar daños de tipo biológico a causa de las propiedades de su radiación y debido a su concentración extrema de potencia electromagnética. En caso de que un producto Rohde & Schwarz contenga un producto láser (p. ej. un lector de CD/DVD), no debe usarse ninguna otra configuración o función aparte de las descritas en la documentación del producto, a fin de evitar lesiones (p. ej. debidas a irradiación láser).
8. Clases de compatibilidad electromagnética (conforme a EN 55011 / CISPR 11; y en analogía con EN 55022 / CISPR 22, EN 55032 / CISPR 32)
  - Aparato de clase A:  
Aparato adecuado para su uso en todos los entornos excepto en los residenciales y en aquellos conectados directamente a una red de distribución de baja tensión que suministra corriente a edificios residenciales.  
Nota: Los aparatos de clase A están destinados al uso en entornos industriales. Estos aparatos pueden causar perturbaciones radioeléctricas en entornos residenciales debido a posibles perturbaciones guiadas o radiadas. En este caso, se le podrá solicitar al operador que tome las medidas adecuadas para eliminar estas perturbaciones.
  - Aparato de clase B:  
Aparato adecuado para su uso en entornos residenciales, así como en aquellos conectados directamente a una red de distribución de baja tensión que suministra corriente a edificios residenciales.

## Instrucciones de seguridad elementales

### Reparación y mantenimiento

1. El producto solamente debe ser abierto por personal especializado con autorización para ello. Antes de manipular el producto o abrirlo, es obligatorio desconectarlo de la tensión de alimentación, para evitar toda posibilidad de choque eléctrico.
2. El ajuste, el cambio de partes, el mantenimiento y la reparación deberán ser efectuadas solamente por electricistas autorizados por Rohde & Schwarz. Si se reponen partes con importancia para los aspectos de seguridad (p. ej. el enchufe, los transformadores o los fusibles), solamente podrán ser sustituidos por partes originales. Después de cada cambio de partes relevantes para la seguridad deberá realizarse un control de seguridad (control a primera vista, control del conductor de protección, medición de resistencia de aislamiento, medición de la corriente de fuga, control de funcionamiento). Con esto queda garantizada la seguridad del producto.

### Baterías y acumuladores o celdas

*Si no se siguen (o se siguen de modo insuficiente) las indicaciones en cuanto a las baterías y acumuladores o celdas, pueden producirse explosiones, incendios y/o lesiones graves con posible consecuencia de muerte. El manejo de baterías y acumuladores con electrolitos alcalinos (p. ej. celdas de litio) debe seguir el estándar EN 62133.*

1. No deben desmontarse, abrirse ni triturarse las celdas.
2. Las celdas o baterías no deben someterse a calor ni fuego. Debe evitarse el almacenamiento a la luz directa del sol. Las celdas y baterías deben mantenerse limpias y secas. Limpiar las conexiones sucias con un paño seco y limpio.
3. Las celdas o baterías no deben cortocircuitarse. Es peligroso almacenar las celdas o baterías en estuches o cajones en cuyo interior puedan cortocircuitarse por contacto recíproco o por contacto con otros materiales conductores. No deben extraerse las celdas o baterías de sus embalajes originales hasta el momento en que vayan a utilizarse.
4. Las celdas o baterías no deben someterse a impactos mecánicos fuertes indebidos.
5. En caso de falta de estanqueidad de una celda, el líquido vertido no debe entrar en contacto con la piel ni los ojos. Si se produce contacto, lavar con agua abundante la zona afectada y avisar a un médico.
6. En caso de cambio o recarga inadecuados, las celdas o baterías que contienen electrolitos alcalinos (p. ej. las celdas de litio) pueden explotar. Para garantizar la seguridad del producto, las celdas o baterías solo deben ser sustituidas por el tipo Rohde & Schwarz correspondiente (ver lista de recambios).
7. Las baterías y celdas deben reciclarse y no deben tirarse a la basura doméstica. Las baterías o acumuladores que contienen plomo, mercurio o cadmio deben tratarse como residuos especiales. Respete en esta relación las normas nacionales de eliminación y reciclaje.

### Transporte

1. El producto puede tener un peso elevado. Por eso es necesario desplazarlo o transportarlo con precaución y, si es necesario, usando un sistema de elevación adecuado (p. ej. una carretilla elevadora), a fin de evitar lesiones en la espalda u otros daños personales.

## Instrucciones de seguridad elementales

2. Las asas instaladas en los productos sirven solamente de ayuda para el transporte del producto por personas. Por eso no está permitido utilizar las asas para la sujeción en o sobre medios de transporte como p. ej. grúas, carretillas elevadoras de horquilla, carros etc. Es responsabilidad suya fijar los productos de manera segura a los medios de transporte o elevación. Para evitar daños personales o daños en el producto, siga las instrucciones de seguridad del fabricante del medio de transporte o elevación utilizado.
3. Si se utiliza el producto dentro de un vehículo, recae de manera exclusiva en el conductor la responsabilidad de conducir el vehículo de manera segura y adecuada. El fabricante no asumirá ninguna responsabilidad por accidentes o colisiones. No utilice nunca el producto dentro de un vehículo en movimiento si esto pudiera distraer al conductor. Asegure el producto dentro del vehículo debidamente para evitar, en caso de un accidente, lesiones u otra clase de daños.

### Eliminación/protección del medio ambiente

1. Los dispositivos marcados contienen una batería o un acumulador que no se debe desechar con los residuos domésticos sin clasificar, sino que debe ser recogido por separado. La eliminación se debe efectuar exclusivamente a través de un punto de recogida apropiado o del servicio de atención al cliente de Rohde & Schwarz.
2. Los dispositivos eléctricos usados no se deben desechar con los residuos domésticos sin clasificar, sino que deben ser recogidos por separado. Rohde & Schwarz GmbH & Co.KG ha elaborado un concepto de eliminación de residuos y asume plenamente los deberes de recogida y eliminación para los fabricantes dentro de la UE. Para desechar el producto de manera respetuosa con el medio ambiente, dirijase a su servicio de atención al cliente de Rohde & Schwarz.
3. Si se trabaja de manera mecánica y/o térmica cualquier producto o componente más allá del funcionamiento previsto, pueden liberarse sustancias peligrosas (polvos con contenido de metales pesados como p. ej. plomo, berilio o níquel). Por eso el producto solo debe ser desmontado por personal especializado con formación adecuada. Un desmontaje inadecuado puede ocasionar daños para la salud. Se deben tener en cuenta las directivas nacionales referentes a la eliminación de residuos.
4. En caso de que durante el trato del producto se formen sustancias peligrosas o combustibles que deban tratarse como residuos especiales (p. ej. refrigerantes o aceites de motor con intervalos de cambio definidos), deben tenerse en cuenta las indicaciones de seguridad del fabricante de dichas sustancias y las normas regionales de eliminación de residuos. Tenga en cuenta también en caso necesario las indicaciones de seguridad especiales contenidas en la documentación del producto. La eliminación incorrecta de sustancias peligrosas o combustibles puede causar daños a la salud o daños al medio ambiente.

Se puede encontrar más información sobre la protección del medio ambiente en la página web de Rohde & Schwarz.



# Quality management and environmental management

Certified Quality System  
**ISO 9001**

Certified Environmental System  
**ISO 14001**

## Sehr geehrter Kunde,

Sie haben sich für den Kauf eines Rohde&Schwarz Produktes entschieden. Sie erhalten damit ein nach modernsten Fertigungsmethoden hergestelltes Produkt. Es wurde nach den Regeln unserer Qualitäts- und Umweltmanagementsysteme entwickelt, gefertigt und geprüft. Rohde&Schwarz ist unter anderem nach den Managementsystemen ISO9001 und ISO 14001 zertifiziert.

## Der Umwelt verpflichtet

- Energie-effiziente, RoHS-konforme Produkte
- Kontinuierliche Weiterentwicklung nachhaltiger Umweltkonzepte
- ISO 14001-zertifiziertes Umweltmanagementsystem

## Dear customer,

You have decided to buy a Rohde&Schwarz product. This product has been manufactured using the most advanced methods. It was developed, manufactured and tested in compliance with our quality management and environmental management systems. Rohde&Schwarz has been certified, for example, according to the ISO9001 and ISO 14001 management systems.

## Environmental commitment

- Energy-efficient products
- Continuous improvement in environmental sustainability
- ISO 14001-certified environmental management system

## Cher client,

Vous avez choisi d'acheter un produit Rohde&Schwarz. Vous disposez donc d'un produit fabriqué d'après les méthodes les plus avancées. Le développement, la fabrication et les tests de ce produit ont été effectués selon nos systèmes de management de qualité et de management environnemental. La société Rohde&Schwarz a été homologuée, entre autres, conformément aux systèmes de management ISO 9001 et ISO 14001.

## Engagement écologique

- Produits à efficience énergétique
- Amélioration continue de la durabilité environnementale
- Système de management environnemental certifié selon ISO 14001



# Customer Support

## Technical support – where and when you need it

For quick, expert help with any Rohde & Schwarz equipment, contact one of our Customer Support Centers. A team of highly qualified engineers provides telephone support and will work with you to find a solution to your query on any aspect of the operation, programming or applications of Rohde & Schwarz equipment.

## Up-to-date information and upgrades

To keep your instrument up-to-date and to be informed about new application notes related to your instrument, please send an e-mail to the Customer Support Center stating your instrument and your wish. We will take care that you will get the right information.

### Europe, Africa, Middle East

Phone +49 89 4129 12345  
[customersupport@rohde-schwarz.com](mailto:customersupport@rohde-schwarz.com)

### North America

Phone 1-888-TEST-RSA (1-888-837-8772)  
[customer.support@rsa.rohde-schwarz.com](mailto:customer.support@rsa.rohde-schwarz.com)

### Latin America

Phone +1-410-910-7988  
[customersupport.la@rohde-schwarz.com](mailto:customersupport.la@rohde-schwarz.com)

### Asia/Pacific

Phone +65 65 13 04 88  
[customersupport.asia@rohde-schwarz.com](mailto:customersupport.asia@rohde-schwarz.com)

### China

Phone +86-800-810-8228 /  
+86-400-650-5896  
[customersupport.china@rohde-schwarz.com](mailto:customersupport.china@rohde-schwarz.com)



## Table of Contents

<b>1</b>	<b>Putting into Operation</b> .....	1.1
	<b>Unpacking the power sensor</b> .....	1.1
	<b>Connecting the power sensor</b> .....	1.1
	<b>Operation with the R&amp;S NRP/NRP2 power meter</b> .....	1.2
	Connecting the power sensor .....	1.2
	<b>PC control</b> .....	1.2
	Hardware and software requirements .....	1.2
	Operation via the R&S NRP-Z4 passive USB adapter .....	1.4
	Connecting the sensor to the DUT .....	1.4
	Operation via the Active USB Adapter R&S NRP-Z3 .....	1.4
	Operation via the R&S NRP-Z5 Sensor Hub .....	1.5
	Equipment Supplied and Alternative Accessories .....	1.5
	Ports and LEDs .....	1.6
	Test Setup .....	1.7
	Troubleshooting .....	1.9
	<b>Operation with other Rohde &amp; Schwarz test instruments</b> .....	1.10
	Hardware and software requirements .....	1.10

**Figs.**

Fig. 1-1	Displaying the total available power of a USB port.....	1.3
Fig. 1-2	Configuration with Passive USB Adapter R&S NRP-Z4 .....	1.4
Fig. 1-3	Configuration with Active USB Adapter R&S NRP-Z3.....	1.4
Fig. 1-4	Changing the primary adapter .....	1.5
Fig. 1-5	Ports and LEDs on front panel.....	1.6
Fig. 1-6	Ports on rear panel .....	1.7
Fig. 1-7	Unlatching the <i>R&amp;S Instrument</i> connector.....	1.7
Fig. 1-8	Typical test setup with R&S NRP-Z5 and PC .....	1.8
Fig. 1-9	Changing the view in Device Manager .....	1.9
Fig. 1-10	Identification of USB root hub on which R&S NRP-Z5 is operated .....	1.9
Fig. 1-11	Deactivation of <i>Selective Suspend</i> for a USB root hub .....	1.10

**Tables**

Table 1-1	RF connectors of R&S NRP-Z5x power sensors.....	1.2
-----------	---	-----

# 1 Putting into Operation

---

**NOTICE** *Follow the instructions below precisely to prevent damage to the power sensor – particularly when you are putting it into operation for the first time.*

---

## Unpacking the power sensor

Remove the power sensor from its packing and check that nothing is missing. Inspect all items for damage. If you discover any damage, inform the carrier responsible immediately and keep the packing to support any claims for compensation.

It is also best to use the original packing if the power sensor is to be shipped or transported at a later date.



*The power sensor contains components which can be destroyed by electrostatic discharges. To prevent this from happening, never touch the inner conductor of the RF connector and never open the power sensor.*

---

## Connecting the power sensor

---

**NOTICE** *To prevent EMI, the sensor must never be operated with its enclosure wholly or partially removed. Only use shielded cables that meet the relevant EMC standards.*

*Never exceed the maximum RF power limit. Even brief overloads can destroy the sensor.*

*The R&S NRP-Z41 and R&S NRP-Z61 power sensors have a new type of ball-bearing RF connector. Since the friction with this design is considerably less than with conventional RF connectors, a reproducible connection is ensured even at relatively low torques. Make sure that the sensor body can still be turned opposite the mating part. Do not try to prevent this by increasing the torque above the permissible value or by tightening the connection by turning the sensor body.*

---

Caused by their different frequency ranges, the R&S NRP-Z11/21/31/41/61/211/221 power sensors have different RF connectors. In this context, the following sections will refer to Table 1-1:

## Operation with the R&S NRP/NRP2 power meter R&S NRP-Z11/21/31/41/61/211/221

Table 1-1 RF connectors of R&S NRP-Z5x power sensors

Power sensor	Male connector	Matching female connector	Tightening torque
R&S NRP-Z11	N	N	1,36 Nm (12" lbs)
R&S NRP-Z21			
R&S NRP-Z211			
R&S NRP-Z221			
R&S NRP-Z31	3,5 mm	3,5 mm/2,92 mm/SMA	0,9 Nm (8" lbs)
R&S NRP-Z41	2,92 mm		
R&S NRP-Z61	2,4 mm	2,4 mm/1,85 mm	

## Operation with the R&S NRP/NRP2 power meter

### Connecting the power sensor

The power sensor can be connected to the R&S NRP base unit when it is in operation. The multiple circular plug-in connector must be inserted, red marking upwards, into one of the R&S NRP base unit's sensor connectors. When the power sensor is connected, it is detected by the R&S NRP base unit and initialized.

See Table 1-1 for the type of male RF connector a certain power sensor has and which female connectors it mates with. Using light pressure, and keeping the male connector perpendicular, insert it into the female connector and tighten the locking nut (right-hand thread). In many cases, the RF connector only requires manual tightening. However, for maximal measurement accuracy, the RF connector must be tightened using a torque wrench with a nominal torque that corresponds with the tightening torque shown in Table 1-1.

## PC control

### Hardware and software requirements

The following requirements must be met if the power sensor is to be controlled by a PC via an interface adapter:

- The PC must have a USB port.
- Either Microsoft Windows XP (32 Bit), Microsoft Windows Vista (32 or 64 Bit), Microsoft Windows 7 (32 or 64 Bit), or x86 Linux (with kernel 2.6.8 oder more recent) must be installed as the operating system of the PC. 64-bit versions of Microsoft Windows XP are not supported. Operation with older versions of Microsoft Windows with USB support (especially Microsoft Windows 2000) is normally possible but cannot be guaranteed.
- The USB device drivers in the supplied *NRP Toolkit* software package must be installed.

If these requirements are met, the power sensor can be controlled using a suitable application program such as the *NrpFlashup* program contained in the Microsoft Windows version of the *NRP Toolkit* (includes the modules *Power Viewer*, *USB Terminal*, *Firmware Update* and *Update S-Parameters*).

When you insert the CD-ROM supplied with the R&S NRP power sensor, the *NRP Toolkit* is automatically installed on your PC. The rest of the procedure is self-explanatory.

The power sensor can be powered in two ways:

- *Self-powered* from a separate power supply via the Active USB Adapter R&S NRP-Z3 or the Sensor Hub R&S NRP-Z5.
- *Bus-powered* from the PC or a USB hub with its own power supply (*self-powered hub*) via the Active USB Adapter R&S NRP-Z3 or via the Passive USB Adapter R&S NRP-Z4.

As the power sensor is a *high-power device*, there is no guarantee that it can be powered from all types of laptop or notebook in the *bus-powered* mode. To be sure, you should determine the current at the USB connectors beforehand:



- In the Windows™ start menu, select **Settings – Control Panel**
- Select the **System** icon
- Select the **Hardware** tab
- By clicking on the button with that name, start the **Device Manager**
- Open **USB Controller** (all USB controllers, hubs and USB devices are listed here)
- Double-click on **USB Root Hub** or select **Properties** in the context menu (use the right-hand mouse button)
- Select the **Power** tab (Fig. 1-1). If the hub is self-powered and the total power available is, as indicated by **Hub Information**, 500 mA per port, high-power devices can be connected.

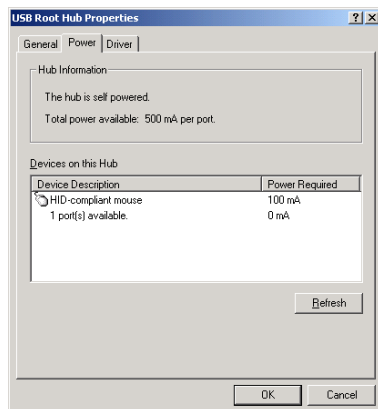

Fig. 1-1 Displaying the total available power of a USB port

If you have any doubts, ask the manufacturer if the USB port on your laptop or notebook can handle *high-power devices*.

### Operation via the R&S NRP-Z4 passive USB adapter

Fig. 1-2 is a schematic of the measurement setup. The order in which the cables are connected is not critical.

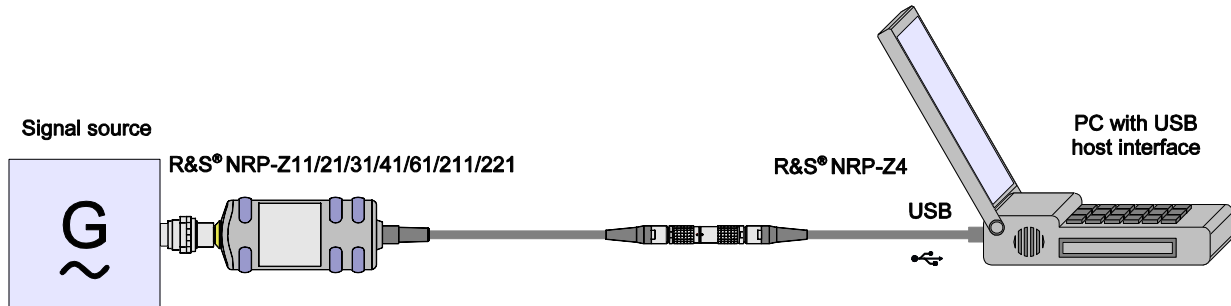

Fig. 1-2 Configuration with Passive USB Adapter R&S NRP-Z4

### Connecting the sensor to the DUT

See Table 1-1 for the type of male RF connector a certain power sensor has and which female connectors it mates with. Using light pressure, and keeping the male connector perpendicular, insert it into the female connector and tighten the locking nut (right-hand thread). In many cases, the RF connector only requires manual tightening. However, for maximal measurement accuracy, the RF connector must be tightened using a torque wrench with a nominal torque that corresponds with the tightening torque shown in Table 1-1.

### Operation via the Active USB Adapter R&S NRP-Z3

Fig. 1-3 shows the configuration with the Active USB Adapter R&S NRP-Z3, which also makes it possible to feed in a trigger signal for the *Timeslot* and *Trace* modes. The order in which the cables are connected is not critical.

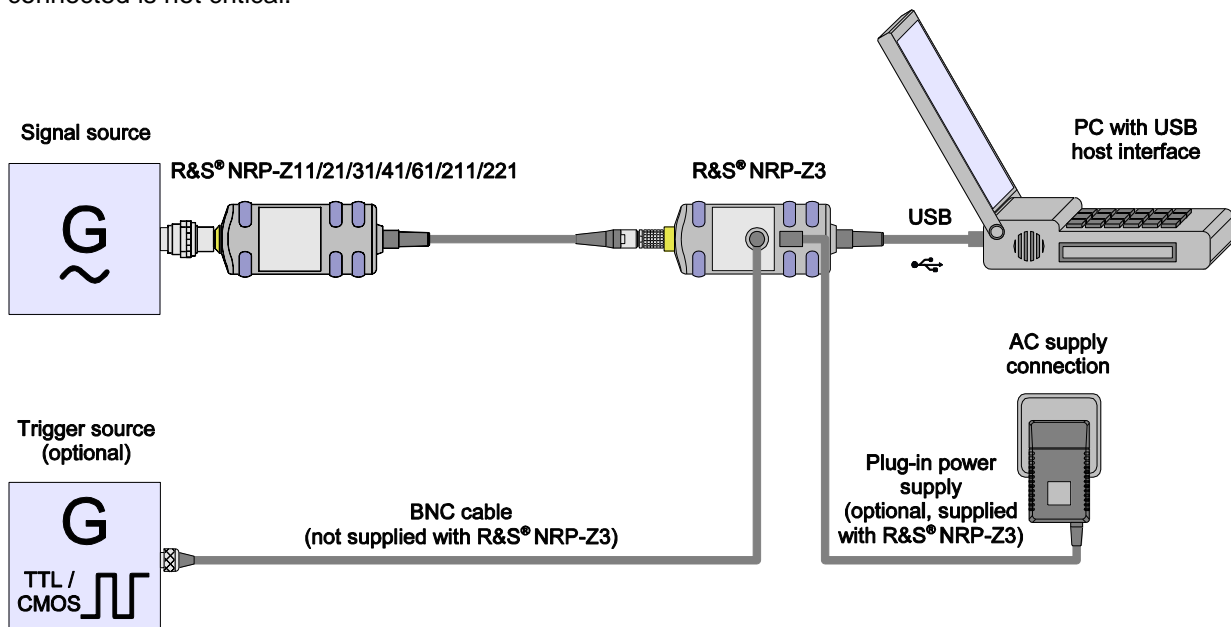

Fig. 1-3 Configuration with Active USB Adapter R&S NRP-Z3



The plug-in power supply for the R&S NRP-Z3 can be powered from a single-phase AC source with a nominal voltage range of 100 V to 240 V and a nominal frequency between 50 Hz and 60 Hz. The plug-in power supply autosets to the applied AC voltage. No manual voltage selection is required.

The plug-in power supply comes with four primary adapters for Europe, the UK, the USA and Australia. No tools of any kind are required to change the primary adapter. The adapter is pulled out manually and another adapter inserted until it locks (Fig. 1-4).

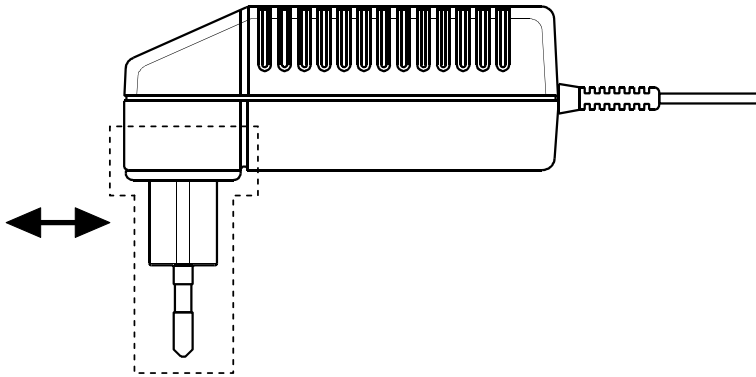

Fig. 1-4 Changing the primary adapter

The plug-in power supply is short-circuit-proof and has an internal fuse. It is not possible to replace this fuse or open the plug-in power supply.

---

**NOTICE** *The plug-in power supply is not intended for outdoor use.*

*Keep within the temperature range of 0°C to 50°C.*

*If there is any condensation on the plug-in power supply, dry it off before connecting it to the AC supply.*

---

## Operation via the R&S NRP-Z5 Sensor Hub

The R&S NRP-Z5 sensor hub allows up to four power sensors to be operated on one PC. It combines the following functions:

- 4-port USB 2.0 hub
- Power supply
- Through-wired trigger bus
- Trigger input and trigger output via BNC sockets

## Equipment Supplied and Alternative Accessories

The following equipment is supplied:

- Sensor hub
- External power supply
- Power cable
- USB cable

Instead of the supplied, 2 m long USB cable, it is possible to use any other USB-2.0-certified cable (USB connector type A to USB connector type B) with a maximum length of 5 m. If a locking connection is required at the instrument end, it is also possible to use the passive R&S NRP-Z4 interface adapter instead of a standard USB cable.

As an alternative to the supplied external power supply, power can also be supplied using a DC voltage source with an output voltage of 12 V to 24 V and a power output of at least 24 W. Make sure that the polarity is correct (positive pole inside, negative pole outside). The alternative DC voltage source must be in the same building as the R&S NRP-Z5 and must be connected to the latter via a cable with a maximum length of 30 m. Power must not be supplied from a low-voltage supply system.

The supplied external power supply is short-circuit-proof and is also protected by an internal fuse. It is not possible to change the fuse or open the unit.

**NOTICE** *The external power supply is not intended for outdoor use.*

*Keep within the temperature range of 0°C to 50°C.*

*If there is any condensation on the external power supply, dry it off before connecting it to the AC supply.*

## Ports and LEDs

The power sensors are connected to the front panel of the R&S NRP-Z5. The ports and LEDs on the front panel of the R&S NRP-Z5 are shown in Fig. 1-5.

- 1–4     Sockets for connecting the power sensors
- 5–8     Green LEDs for indicating normal operation
- 9–12    Yellow LEDs for indicating faults

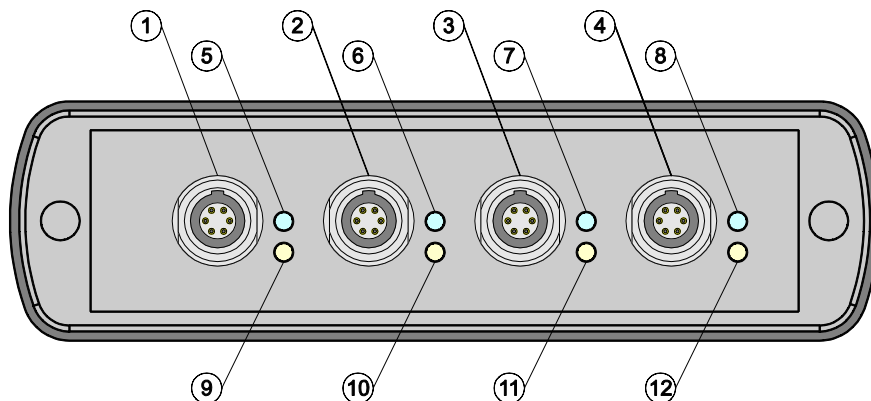

Fig. 1-5     Ports and LEDs on front panel

On the rear panel are the ports for power supply, USB host, trigger input and trigger output. The ports on the rear panel are shown in Fig. 1-6.

- 1     Trigger output (BNC socket)
- 2     Trigger input (BNC socket)
- 3     Built-in plug allowing connection to Rohde & Schwarz measuring instruments (via R&S NRP-Z2) or to a PC (via R&S NRP-Z4)
- 4     USB socket (type B) for connection to the USB host (PC or Rohde & Schwarz measuring instrument without sensor socket)
- 5     Power supply socket (supplied external power supply unit or alternative power supply (12 V to 24 V/24 W))

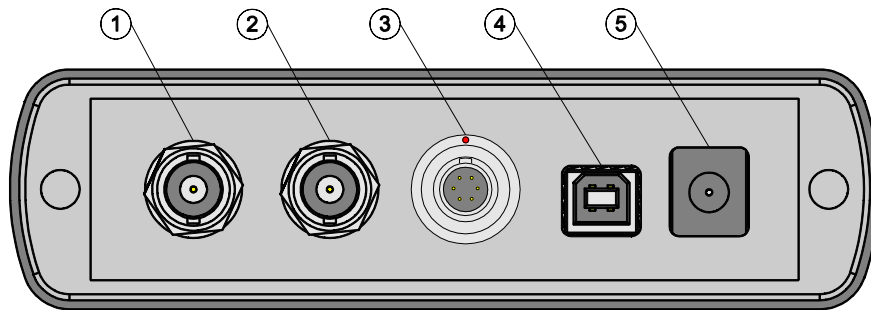
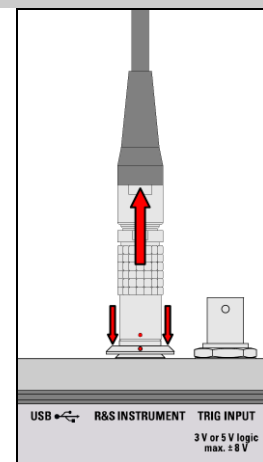

Fig. 1-6 Ports on rear panel



Unlatch the R&S Instrument connector on the rear panel by pressing down the unlatching ring of the built-in plug and pulling off the cable jack at the same time (Fig. 1-7).

Fig. 1-7 Unlatching the R&amp;S Instrument connector



## Test Setup

Fig. 1-8 shows a typical test setup:

- 1 R&S NRP-Z5 sensor hub
- 2 External power supply unit (supplied)
- 3 Power cable (supplied)
- 4 AC power supply
- 5 USB cable (supplied)
- 6 PC with USB host port
- 7, 8 BNC cable (optional, not supplied)
- 9 Trigger source (optional)
- 10 Triggered device (optional)
- 11-14 R&S NRP-Zxx power sensors (one to four sensors)
- 15 Signal source

The sequence in which the cables are connected is not important.

As already mentioned in section *Ports and LEDs*, the R&S NRP-Z4 passive interface adapter can also be used as an alternative to a standard USB cable for connecting to the PC. This adapter is connected to the *R&S Instrument* port. Simultaneous operation at two USB hosts is not possible as the USB host connected to the *R&S Instrument* port always has priority.

It is possible to cascade several R&S NRP-Z5 sensor hubs by connecting the *R&S Instrument* port of an R&S NRP-Z5 to one of the sensor ports of another R&S NRP-Z5. However, external triggering and the use of the *Trigger Master* function are then not possible. Instead, it is recommended to connect all R&S NRP-Z5 hubs individually to the USB host or to an interposed USB hub, and to feed the external trigger signal to all R&S NRP-Z5 hubs via their trigger inputs; or to forward the external trigger signal from the trigger output of the R&S NRP-Z5 to which the *Trigger Master* is connected to the trigger inputs of the other R&S NRP-Z5 hubs.

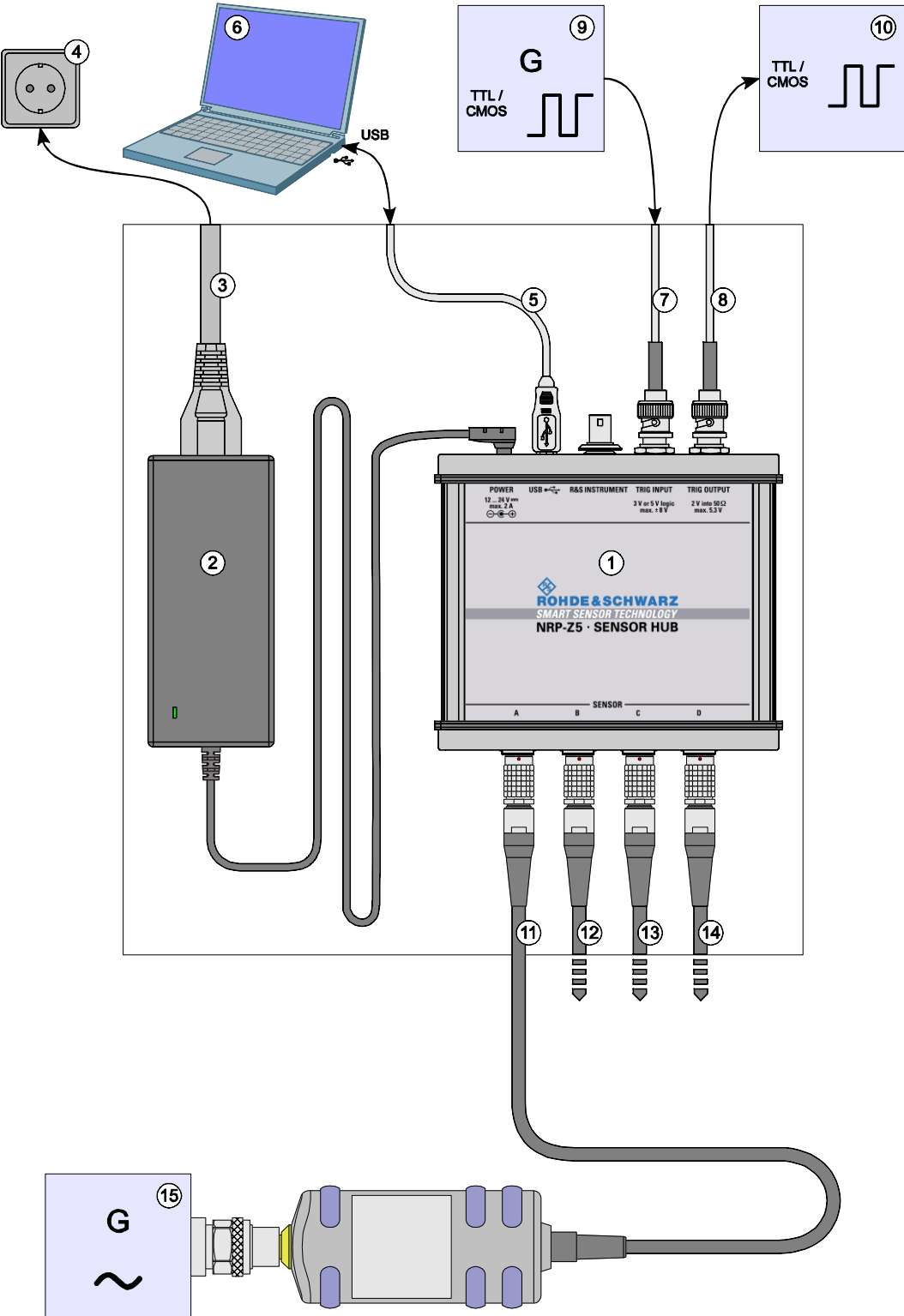

Fig. 1-8 Typical test setup with R&S NRP-Z5 and PC

## Troubleshooting

A frequent problem, especially in the case of operation under Microsoft Windows XP, is that the R&S NRP-Z5 fails to respond after a power sensor connected to the R&S NRP-Z5 is disconnected and reconnected. It is then necessary to restart the PC.

This problem is not specific to the R&S NRP-Z5, but occurs with all USB hubs. You can try to eliminate the problem by switching off the *Selective Suspend* for the USB port of the PC on which the R&S NRP-Z5 is operated. The following step-by-step description is based on an English version of Windows XP:

1. Connect the R&S NRP-Z5 and put it into operation. Connect at least one power sensor.
2. Start the Device Manager and change the view by selecting **View - Devices by connection** (Fig. 1-9).

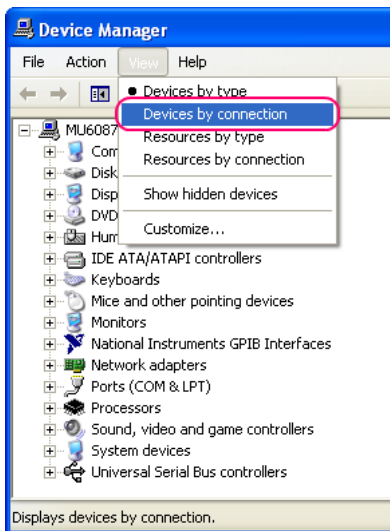

Fig. 1-9 Changing the view in Device Manager

3. Now identify the USB root hub on which the R&S NRP-Z5 is operated. To do so, expand the hierarchical display of the PC components, as shown in Fig. 1-10. Under **PCI bus**, find the USB host controller to whose root hub the R&S NRP-Z5 is connected. The R&S NRP-Z5 is shown as the **Generic USB Hub**. It can be distinguished from other USB hubs by the power sensor connected to it.

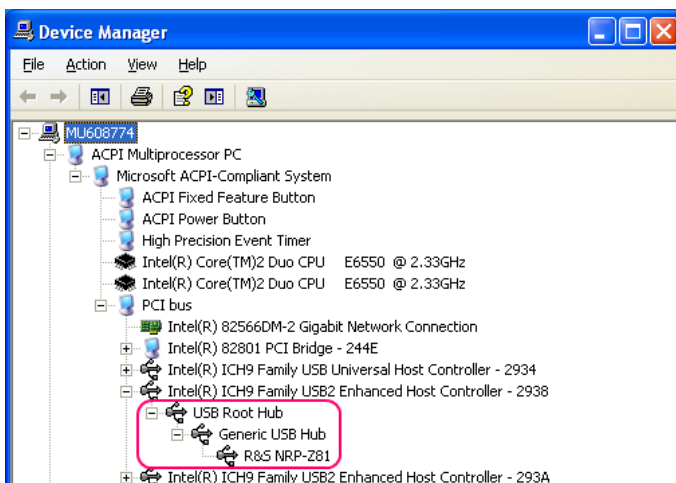

Fig. 1-10 Identification of USB root hub on which R&S NRP-Z5 is operated

4. Double-clicking **USB Root Hub** opens the **USB Root Hub Properties** dialog box. Select the Power Management tab. Remove the check mark next to **Allow the computer to turn off this device to save power** and confirm this with **OK**.

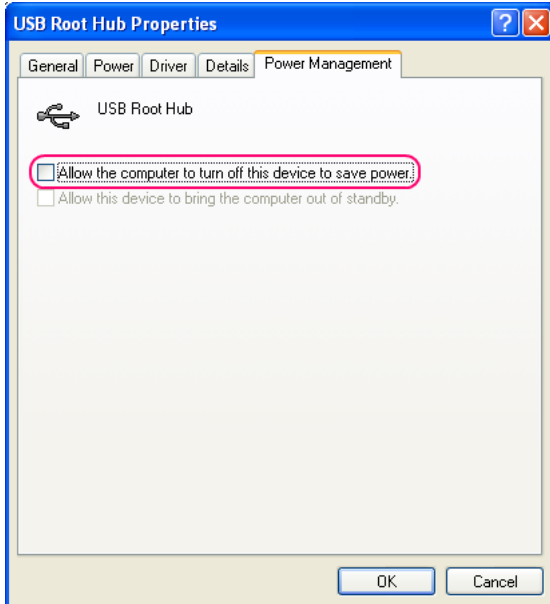

Fig. 1-11 Deactivation of *Selective Suspend* for a USB root hub

## Operation with other R&S test instruments

### Hardware and software requirements

Many Rohde & Schwarz test instruments allow power measurements using power sensors of the R&S NRP-Zxx series. The power sensors are generally connected to the USB ports of the test instrument via one of the two interface adapters, R&S NRP-Z3 or R&S NRP-Z4, or the Sensor Hub R&S NRP-Z5. On some instruments, such as the R&S SMU signal generator, there is also an R&S NRP sensor connector available for a direct connection. The R&S NRP-Z5 can be hooked up to this connector via an extension cable R&S NRP-Z2 (Model .03, .05, or .15). For that purpose, the *R&S Instrument* connector of the R&S NRP-Z5 is used.

## Table of Contents

<b>2</b>	<b>Virtual Power Meter .....</b>	<b>2.1</b>
	<b>Overview.....</b>	<b>2.1</b>
	Menus .....	2.3

**Figs.**

Fig. 2-1      **Power Viewer** virtual power meter .....2.1

**Tables**

Table 2-1    Virtual power meter keys .....2.2  
Table 2-2    Virtual power meter entry fields .....2.2



## 2 Virtual Power Meter

You will find the **NrpFlashup** program that enables you to operate the power sensor with a PC under Windows™ on the CD-ROM that accompanies the power sensor. The program comprises several modules which can be started centrally via the Windows™ start-menu entry **NRP Toolkit**.

This section describes the **Power Viewer** program module. This is a virtual power meter which only uses a cut-down set of the power sensor's functions. This means that after an extremely brief familiarization period, you can perform measurements.

The other modules in **NrpFlashup** are described in Chapter 3 of the operating manual (**Terminal** and **Update S-Parameters** modules) or in the service manual (**Firmware Update** module).

### Overview

Start the virtual power meter using the **NRP Toolkit – Power Viewer** start-menu entry. The **Power Viewer** program window is displayed (Fig. 2-1).

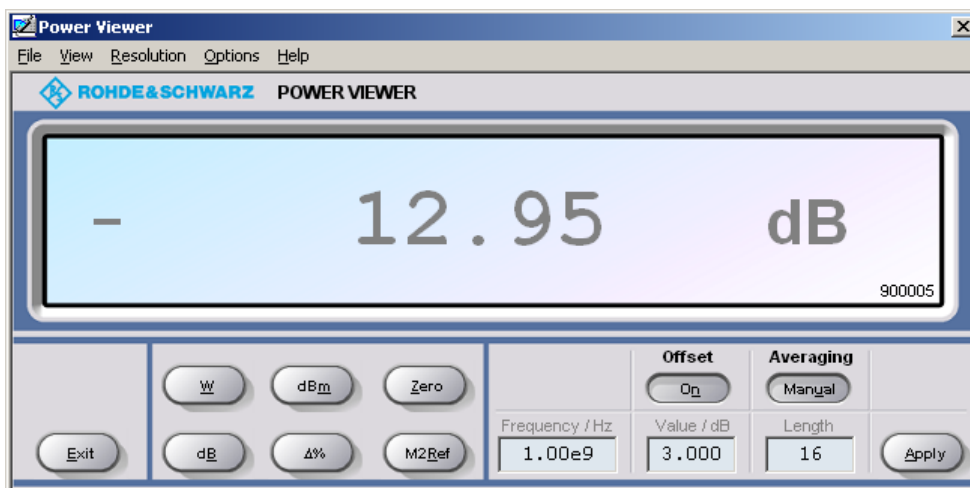

Fig. 2-1 **Power Viewer** – virtual power meter

The result display occupies most of the program window. The result, unit and additional power sensor status information are displayed. The serial number is displayed in the bottom right. The program window also contains animated buttons and entry fields (see Table 2-1 and Table 2-2).

Table 2-1 Virtual power meter keys

Button	Function	Key combination
Exit	Terminates the program. The current settings are saved and recalled the next time the program is started.	Alt + E
W	Selects Watt as the display unit.	Alt + W
dBm	Selects dBm as the display unit.	Alt + M
Zero	Zeroes the power sensor.	Alt + Z
dB	Selects dB as the display unit. This is the log of the ratio of the measured value to the reference value.	Alt + B
Δ%	Selects % as the display unit. The difference between the measured value and the reference value is expressed as a percentage.	Alt + %
M2Ref	Makes the current measured value the reference value for the relative display units dB and %.	Alt + R
Offset On/Off	Turns the global offset correction for the power sensor on or off. If the offset correction is Off, the <b>Offset/dB</b> entry field has a grey background.	Alt + N
Averaging Man/Auto	Turns auto-averaging on or off. When auto-averaging is on, the <b>Length</b> entry field has a grey background; the current averaging factor is displayed.	Alt + T
Apply	Accepts edited numerical values in the <b>Frequency/Hz</b> , <b>Value/dB</b> and <b>Length</b> entry fields and transfers them to the sensor.	Alt + A or Enter key

Table 2-2 Virtual power meter entry fields

Entry field	Function
Frequency/Hz	Frequency of the RF carrier in Hertz.
Value/dB	Attenuation in dB of the component connected to the power sensor. The valid range is -100 to 100. The global offset correction must be activated beforehand with the <b>Offset On/Off</b> button if this entry field is to be edited.
Length	Length of the averaging filter (= averaging factor). The valid range is 1 to 65536. Averaging must be set to manual with the <b>Averaging Man/Auto</b> button if this entry field is to be edited.

Scientific notation can also be used for the entry fields. If an invalid entry is made, an error message is output. An edited numerical value will not be transferred to the sensor unless you use the **Apply** button or the Enter key to terminate the entry.

## Menus

The menu bar can be used to call less frequently used functions.

<b>File</b>	<b>Start Log ...</b>	<p>Opens a file-selection dialog to specify the path and name of the log file. Clicking the <b>Save</b> button starts the recording. All displayed values are written line-by-line to the log file with the date (format: YY/MM/DD) and time (format: hh:mm:ss.ms). Example: -22.51 dBm (03/02/25 15:37:25.310)</p>
	<b>Stop Log</b>	<p>Ends the log-file recording.</p>
<b>View</b>	<b>Display Refresh Rate</b>	<p>Opens a dialog box to adjust the display refresh rate. The time in milliseconds between two refresh operations is entered. The default setting is 200 ms.</p>
	<b>Colours</b>	<p>Opens a dialog box to select the background colour for</p> <ul style="list-style-type: none"> <li>• the result,</li> <li>• the unit,</li> <li>• the text in the number fields or</li> <li>• the key labelling.</li> </ul>
	<b>Result Unit Edit Button</b>	
<b>Resolution</b>		<p>For setting the result resolution. If auto-averaging has been selected, a higher resolution leads to a greater averaging factor, which means a longer result settling time.</p>
<b>Options</b>	<b>Read Sensor Status ...</b>	<p>Reads the current status of the power sensor. A parameter list is output.</p>
	<b>Read Error Queue ...</b>	<p>Reads the error queue. All the error messages that have been issued since the last call are read line-by-line. A tick before this menu entry indicates that an error has occurred.</p>

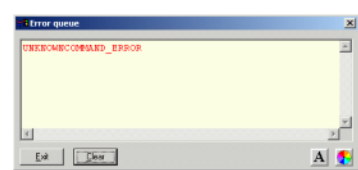
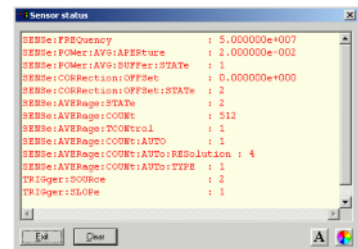
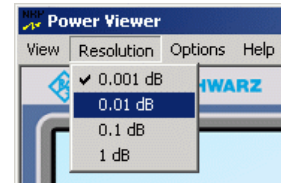

**Simulation ...**

Allows you to try out the functions of the virtual power meter even without a power sensor. The display alternates between **Measurement Value 1 & Measurement Value 2** with a period given by **Interval**. Simulation can be activated immediately with the **Activate** check box.

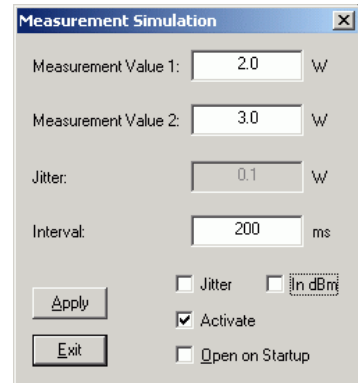

**Reset Sensor**

Initializes the power sensor. Any previous zeroing remains valid.

**Help**

**Contents**

Opens the table of contents for the online-help facility.

**About**

Displays information about the program version used, etc.

## Table of Contents

<b>3</b>	<b>Manual Operation</b> .....	3.1
	<b>Program module "Terminal"</b> .....	3.1
	Main control elements.....	3.1
	Menus .....	3.3
	<b>Program module "Firmware Update"</b> .....	3.6
	<b>Program module "Update S-Parameters"</b> .....	3.6
	Fundamentals .....	3.6
	Procedure .....	3.9

**Figs.**

Fig. 3-1 Sending commands using the **Input** field .....3.1  
Fig. 3-2 Sending commands using command files .....3.2  
Fig. 3-3 Dialog window for loading an s-parameter table.....3.9  
Fig. 3-4 Dialog window for loading the backup file of a calibration data set .....3.10  
Fig. 3-5 Subsequently changing the default behaviour of the s-parameter correction .....3.11

**Tables**

Table 3-1 Buttons assigned to the **Input** field .....3.2  
Table 3-2 Buttons assigned to the **Command File** field .....3.2  
Table 3-3 Buttons assigned to the **Output** field .....3.3  
Table 3-4 Uncertainties of the s-parameter test system (example) .....3.7  
Table 3-5 Interpolated uncertainties of measurement frequencies for s-parameters (example) .....3.7

### 3 Manual Operation

The previous section describes the **Power Viewer** program module supplied with the instrument. This module simplifies the most frequently used function of a power meter – measuring the average power of an RF signal of almost any modulation. Other program modules are also part of the supplied equipment and can be selected in the Start menu:

- **Power Viewer:** A detailed description of this virtual power meter module is provided in section 2.
- **Terminal:** Program module for sending commands and command sequences to the sensor and for displaying measurement results, status information and other data from the sensor
- **Firmware Update:** Program module for updating the sensor firmware
- **Update S-Parameters:** Program module for loading an s-parameter table into the sensor

### Program module "Terminal"

#### Main control elements

With the USB terminal, commands and command sequences can be sent to the sensor in two different ways:

- Commands are entered in the **Input** field (Fig. 3-1). Consecutive commands can be entered as separate lines, one below the other. The buttons associated with the **Input** field are described in Table 3-1.
- Commands or command sequences are stored in *command files*. Command files are created with a text editor, for instance, and then stored. They can be called as often as required (Fig. 3-2). The buttons of the **Command File** field are described in Table 3-2.

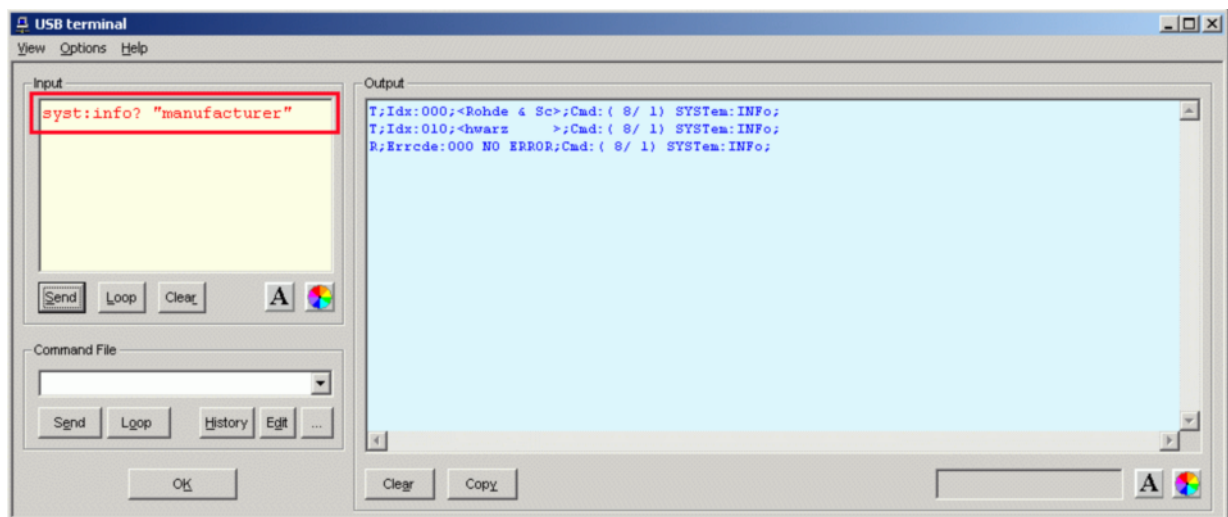

Fig. 3-1 Sending commands using the **Input** field

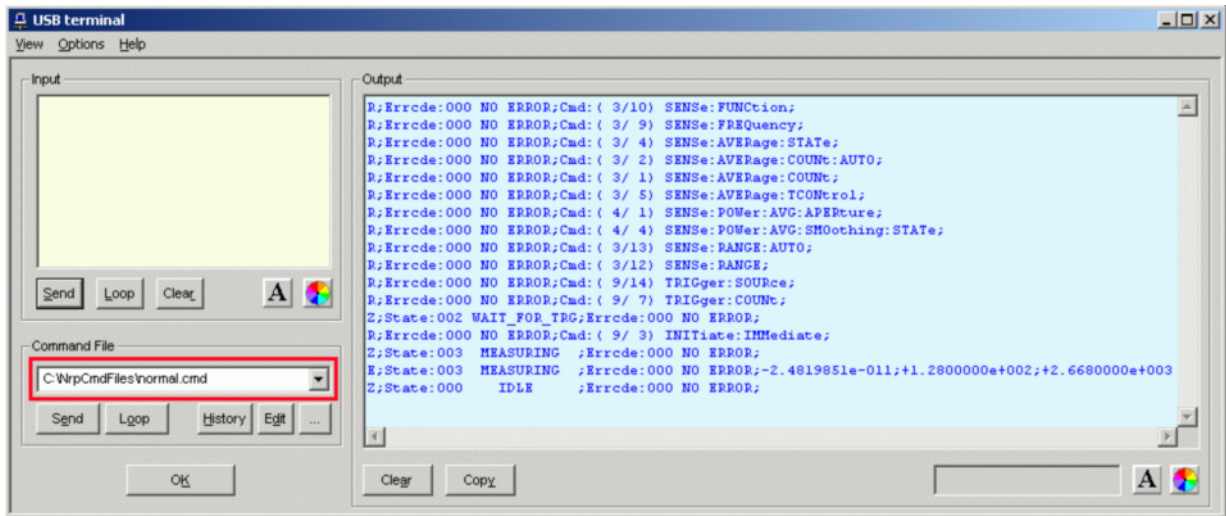

Fig. 3-2 Sending commands using command files

Table 3-1 Buttons assigned to the **Input** field

Button	Function	Key combination
Send	Sends the content of the <b>Input</b> entry field to the sensor.	Alt + S
Loop	With <b>Loop</b> the command or command sequence is cyclically sent. Pressing the button again terminates the cyclic transmission. The repetition rate is set in a dialog window that can be opened with <b>View - Loop...</b>	Alt + L
Clear	Clears the content of the <b>Input</b> field.	Alt + R
Font key	Opens a dialog window where the font for the <b>Input</b> field can be selected.	
Colour key	Opens a dialog window where the background colour of the <b>Input</b> field can be selected.	

Table 3-2 Buttons assigned to the **Command File** field

Button	Function	Key combination
Send	Sends the content of the command file to the sensor.	Alt + E
Loop	With <b>Loop</b> the command or command sequence is cyclically sent. Pressing the button again terminates the cyclic transmission. The repetition rate is set in a dialog window that can be opened with <b>View - Loop...</b>	Alt + O
History	Opens a window for editing the command file name in the <b>Command File</b> field.	Alt + H
Edit	Opens the selected command file in the Windows™ text editor.	Alt + D
...	Opens a file opening dialog for selecting the command file.	



A command line starting with a tab, a blank or a special character is considered a comment and not forwarded to the sensor.

Measurement results, parameters and status information returned by the sensor are displayed in the **Output** field.

Table 3-3 Buttons assigned to the **Output** field

Button	Function	Key combination
Clear	Clears the content of the <b>Output</b> field	Alt + A
Copy	Copies the content of the <b>Output</b> field to the clipboard. (Another possibility: mark the desired information in the output window with the mouse cursor, press the right mouse key or Ctrl+C and then copy the selected text to the clipboard using the menu item <b>Copy</b> in the opened context menu.)	Alt + Y
Font button	Opens a dialog window where the font for the <b>Output</b> field can be selected.	
Colour button	Opens a dialog window where the background colour of the <b>Output</b> field can be selected.	

Close the USB terminal with OK.

## Menus

**View Post Filter ...** Opens the **Output Postfilter** dialog window where the lines stored in the input buffer can be filtered according to different criteria.

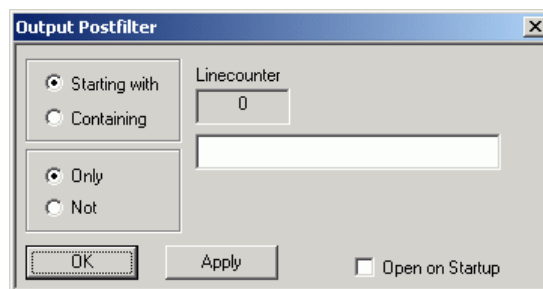

Filter criteria:

**Only + Starting with:** Only lines starting with the entered character string are displayed.

**Not + Starting with:** Only lines not starting with the entered character string are displayed.

**Only + Containing:** Only lines containing the entered character string are displayed.

**Not + Containing:** Only lines not containing the entered character string are displayed.

Lines not matching the specific filter criterion are blanked but not cleared.

Filtering is started with **Apply**. The number of lines matching the filter criterion is displayed in the **Linecounter** field. If **Open on startup** is active, the **Output Postfilter** dialog is automatically opened when the terminal is started. The dialog window is closed with **OK**.

**Response Time ...**

Opens the **Response time** dialog window where the response time of the sensor can be set.

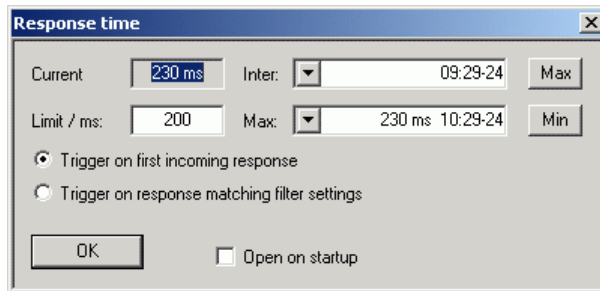

**Current** indicates the time elapsed between dispatch of the last command and receipt of an acknowledgement from the sensor. When the **Max** button is clicked, the response times exceeding the value in the **limit / ms** field are recorded. When the **Min** button is clicked, the response times within the value in the **limit / ms** field are recorded.

If **Trigger on first incoming response** is active, the time measurement is terminated as soon as the first response arrives after a command is sent. If **Trigger on response matching filter settings** is active, the time measurement is terminated as soon as the first response matching the filter criterion in the **Output Postfilter** dialog window is received.

If **Open on startup** is active, the **Response Time** dialog is automatically displayed when the Terminal module is started. The dialog window is closed with **OK**.

**Loop ...**

Opens the **Loop controls** dialog window where the cyclic transfer of commands and command sequences can be controlled.

In the **Delay / ms** field, the time interval for the cyclic transfer is specified in milliseconds.

The number of completed transfer cycles is displayed in the **Counter** field. If **Open on startup** is active, the **Response time** dialog is automatically opened when the Terminal module is started. The dialog window is closed with **OK**.

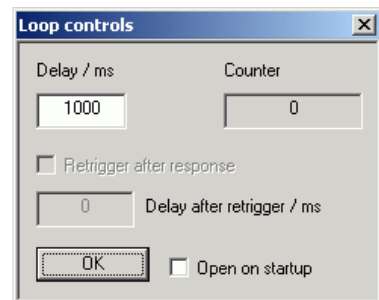

<b>Options</b>	<b>Protocol Mode</b>	In this mode, a time stamp is added to each response block.
	<b>Hex Mode</b>	In this mode, the response blocks from the sensor are displayed in hexadecimal format.
	<b>Auto Delete</b>	With this option active, the <b>Output</b> field is automatically cleared when the <b>Send</b> button is pressed.
	<b>Auto Scroll</b>	With this option active, older items in the <b>Output</b> field are automatically shifted upward and off the display if space is required for new values.
	<b>LF at EOT</b>	With this option active, a line feed is appended to each response block from the sensor.
	<b>Delete on Start</b>	With this option active, the <b>Output</b> field is automatically cleared when the Terminal module is started.
	<b>Send as Hex</b>	With this option active, the text in the <b>Input</b> field is interpreted as a hexadecimal character sequence.
	<b>Advanced ...</b>	Opens a dialog window where the buffer size for the <b>Output</b> field can be set.

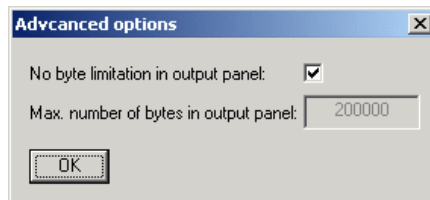
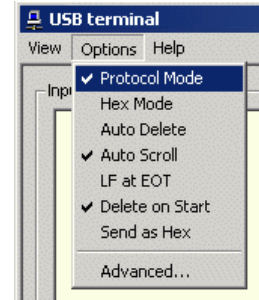

<b>Help</b>	<b>Contents</b>	Opens the table of contents for the online help.
	<b>About</b>	Displays information about the program version, etc.

## Program module "Firmware Update"

A detailed description of the program module for firmware updates is provided in the Service Manual.

## Program module "Update S-Parameters"

### Fundamentals

With the power sensor R&S NRP-Z11/21/31/41/61/211/221, the influence of any twoport – e.g. an adapter – between the signal source and the sensor input can be considered, allowing the power  $P$  actually delivered by the signal source to be calculated.

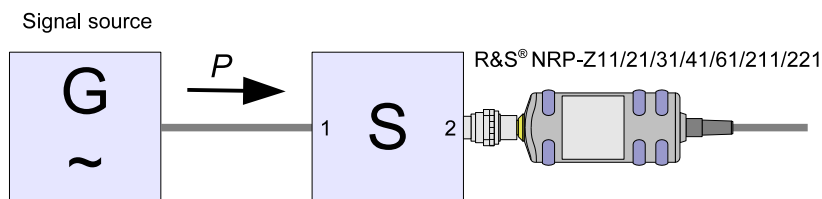

Fig. 3-1 Operation with twoport between signal source and sensor input

A precondition is that a complete set of s-parameter data of the twoport is available in the frequency range in question. The set of calibration data of the sensor therefore includes a table with up to 1000 measurement frequencies. The real and the imaginary part as well as the uncertainty of the s-parameters  $s_{11}$ ,  $s_{12}$ ,  $s_{21}$  and  $s_{22}$  are stored for each frequency.

The measurement frequencies in the s-parameter table can be selected independent of the calibration frequencies of the sensor, allowing the twoport frequency range of interest to be optimally covered. The real and the imaginary parts between these measurement frequencies are linearly interpolated. Below the first and above the last measurement frequency, the values of the first and the last measurement frequency are used, respectively.

The NrpFlashup program (menu item **Update S-Parameters**) is used for loading an s-parameter table. To ensure compatibility with a great number of network analyzers, the program module **Update S-Parameters** can process measurement data files in S2P format. All standard frequency units (Hz, kHz, MHz, GHz) and display formats (real and imaginary part, linear magnitude and phase, magnitude in dB and phase) are supported. The only restriction is that a reference impedance of  $50\ \Omega$  must be used for the s-parameters. Additional noise parameters in the measurement data file are ignored.

Structure of the S2P measurement data file:

1. The *option line* has the following format (square brackets indicate that the enclosed content is optional):

```
# [<frequency unit>] [<parameter>] [<format>] [<R n>]
```

# identifies the *option line*.

The <frequency unit> may be Hz, kHz, MHz or GHz. If a frequency unit is not specified, GHz is implicitly assumed.

If a parameter is specified, S must be used in <parameter> for s-parameter files. If a parameter is not specified, S is implicitly assumed.

The <format> may be MA (linear magnitude and phase in degree), DB (magnitude in dB, phase in degree) or RI (real and imaginary part). If a format is not specified, MA is implicitly assumed.

R is optional and followed by the reference impedance in  $\Omega$ . If an entry is made for R, R50 must be specified. If no entry is made, R50 is implicitly assumed.

The *option line* should therefore read:

# [HZ | KHZ | MHZ | GHZ] [S] [MA | DB | RI] [R 50]

2. The measurement frequencies in ascending order are specified as follows:

$$f_i \quad s_{11}(f_i) \quad s_{21}(f_i) \quad s_{12}(f_i) \quad s_{22}(f_i),$$

where  $s_{jk}(f_i)$  is the display format as specified in the *option line*:

$$\left| s_{jk}(f_i) \right| \quad \arg s_{jk}(f_i) \quad \text{(display format for linear magnitude and phase in degree) or}$$

$$20 \cdot \lg \left| s_{jk}(f_i) \right| \quad \arg s_{jk}(f_i) \quad \text{(display format for magnitude in dB and phase in degree)}$$

$$\operatorname{Re} \left[ s_{jk}(f_i) \right] \quad \operatorname{Im} \left[ s_{jk}(f_i) \right] \quad \text{(display format for real and imaginary part)}$$

3. Comments: Any line starting with an exclamation mark (!) is interpreted as a comment line.

To characterize the measurement uncertainty of the s-parameter test system, another data file can optionally be created. The syntax of the uncertainty data file is similar to that of the S2P data file but U is specified as <Parameter> in the *option line* so that the *option line* reads # Hz U for frequencies in Hz. The measurement frequencies must not be identical to those of the S2P measurement data files. In most cases a few entries will be sufficient to characterize the measurement uncertainty of the s-parameter test system. An s-parameter uncertainty as high as that of the neighbouring measurement frequencies of the uncertainty data file is then selected. If different values are available, the higher one is chosen. This is illustrated in the example below:

Table 3-4 Uncertainties of the s-parameter test system (example)

f in GHz	unc [S <sub>ik</sub> (f)]
0.1	0.01
1.0	0.01
1.1	0.005
10.0	0.005
10.1	0.01
40.0	0.01

Table 3-5 Interpolated uncertainties of measurement frequencies for s-parameters (example)

f in GHz	unc [S <sub>ik</sub> (f)]
0.9	0.01
0.95	0.01
1.0	0.01
1.05	0.01
1.1	0.005
1.15	0.005
1.2	0.005

At 1.05 GHz, the higher uncertainty of the two adjacent 1.0 GHz and 1.1 GHz measurement frequencies is entered in the s-parameter table. If an uncertainty of 0.005 is desired for all frequencies above 1.0 GHz, the first measurement frequency in the uncertainty data file must be above 1.0 GHz, e.g. 1.000001 GHz.

Structure of the uncertainty data file (square brackets indicate that the enclosed content is optional):

1. The *option line* has the following format:

# [<frequency unit>] <parameter> [<format>] [<R n>]

# identifies the *option line*.

The <frequency unit> may be Hz, kHz, MHz or GHz. If a frequency unit is not specified, GHz is implicitly assumed.

U must be specified for <parameter> in uncertainty data files. If a parameter is not specified, S is implicitly assumed and as a result an error message is triggered.

<format> is ignored in uncertainty measurement files; the entry is therefore irrelevant.

R is optional and followed by the reference impedance in  $\Omega$ . If an entry is made for R, R50 must be specified. If no entry is made, R50 is implicitly assumed.

The *option line* should therefore read:

# [HZ | KHZ | MHZ | GHZ] U [MA | DB | RI] [R 50]

2. Measurement frequencies in ascending order are specified in the following form:

$f_i$  unc [ $s_{11}(f_i)$ ] unc [ $s_{21}(f_i)$ ] unc [ $s_{12}(f_i)$ ] unc [ $s_{22}(f_i)$ ].

The s-parameters uncertainties are forwarded as follows:

- as extended absolute uncertainties ( $k = 2$ ) for the magnitude of reflection parameters  $s_{11}$  and  $s_{22}$ , for instance 0.015,
- as extended uncertainties ( $k = 2$ ) in dB for the magnitude of transmission parameters  $s_{21}$  and  $s_{12}$ , for instance 0.015.

3. Comments: Any line starting with an exclamation mark (!) is interpreted as a comment line.

Two additional values must be specified when the s-parameters are loaded: the lower and the upper nominal measurement limit of the sensor-twoport combination. If s-parameter correction is active, these values are transferred by the sensor in response to *SYSTEM:INFO?* The values cannot always be derived from the lower or upper measurement limit of the sensor alone and from the loss or gain of the preconnected twoport. The upper measurement limit of the sensor-twoport combination may also be limited by the twoport's maximum power-handling capacity. Furthermore, the lower measurement limit may be raised not only by the loss but also by the inherent noise of the twoport. For this reason, these values must be entered manually.

---

**NOTICE** *The upper nominal measurement limit of the sensor-twoport combination entered when loading the s-parameters should be carefully specified, as automatic test systems may evaluate it and an incorrect value may cause the sensor and/or the twoport to be overloaded.*

---

## Procedure

To load an s-parameter table into the calibration set of the sensor, proceed as follows:

1. Connect the sensor to the USB port of the PC and start the program module **Update S-Parameters**. The corresponding dialog window is opened (Fig. 3-3).
2. Make sure **Keep Current S-Parameter Data** is deactivated.
3. Under **S-Parameter File** enter the search path and the name of the S2P file containing the parameters. Press the **Browse...** button to open a file-opening dialog where the S2P measurement data file can be easily selected.
4. Under **Uncertainty File** enter the search path and the name of the measurement uncertainty file containing the measurement uncertainty of the s-parameter test system. Press the **Browse...** button to open a file-opening dialog where the measurement uncertainty file can be easily selected.
5. Enter the upper and lower nominal measurement limit of the sensor-twoport combination in the **Lower Power Limit** and **Upper Power Limit** fields.
6. Enter a name for the loaded s-parameter set in the **S-Parameter Device Mnemonic** field. This name can later be queried with `SYSTem:INFO? "SPD Mnemonic"` and is displayed on the NRP basic unit when s-parameter correction is switched on.
7. Activate **S-Parameter Correction on by Default** if the `SENSe:CORRection:SPDevice:STATe` switch should be automatically set to *ON* when the sensor is put into operation.
8. Designations for calibration laboratory and person responsible for calibration may be entered in the **Calibration Lab** and **Calibration Engineer** fields. These designations are stored in the calibration data set. They are implicitly set to „user lab“ and „user“, respectively, if the fields are left blank.
9. Press **Start** for loading. (The dialog is closed with **OK** and the set parameters are retained. When the dialog is exited with **Cancel**, all parameter modifications are ignored.)

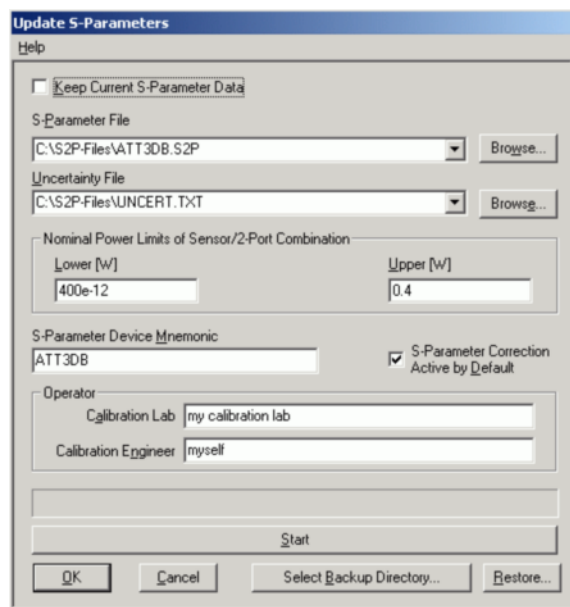

Fig. 3-3 Dialog window for loading an s-parameter table

During loading, the current calibration data set of the sensor is overwritten. To be on the safe side, a backup copy of the current calibration data set is therefore automatically stored before s-parameters are loaded. The names of the backup files have the structure <type>\_<batch number>\_<date>\_<time>.bak, where <type> is the sensor type, <batch number> is the batch number of the sensor, <date> the date of the s-parameter update in yyyyymmdd format and <time> the time of the s-parameter update in the format hhmmss. By default, a subdirectory named "Backup" is created for the backup files in the program directory. With **Select Backup Directory ...** it is possible to select a different directory.



*Store the automatically created backup files on a separate data medium (e.g. diskette, CD-ROM or network drive) and, if required, assign a meaningful name to them to simplify reloading. With the aid of these files, a previously used calibration data set of the sensor can be restored.*

To reload the backup file of a calibration data set into the sensor, proceed as follows:

1. Press the **Restore...** button. The **Restore S-Parameters** window is opened (Fig. 3-4).
2. Enter the search path and the name of the backup file in the **Backup File** field. Press the **Browse...** button to open a dialog where the backup file can be easily selected.
3. Press **OK** to start the restore procedure. (With **Cancel** the dialog window is exited without data being restored).

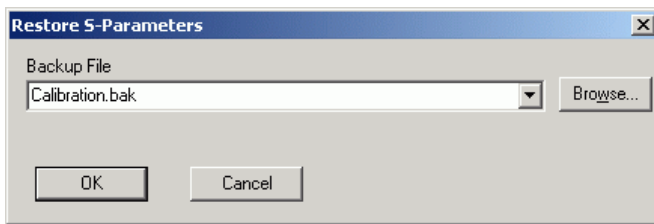

Fig. 3-4 Dialog window for loading the backup file of a calibration data set

To be able to determine if the s-parameter correction is active after plugging in or resetting the sensor, proceed as follows:

1. Connect the sensor to the USB port of the PC and start the program module **Update S-Parameters**.
2. Make sure **Keep Current S-Parameter Data** is activated (Fig. 3-5).
3. Activate **S-Parameter Correction on by Default** if the *SENSe:CORRection:SPDevice:STAtE* switch should be automatically set to *ON* when the sensor is put into operation, otherwise deactivate it.
4. Press **Start** for loading.



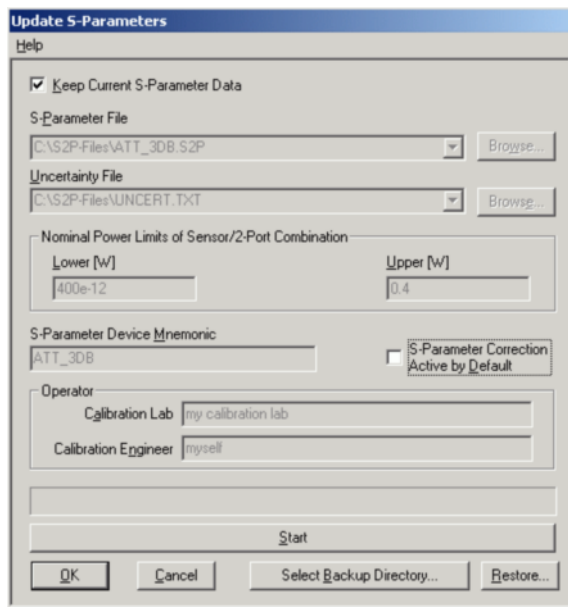

Fig. 3-5 Subsequently changing the default behaviour of the s-parameter correction

**Table of Contents**

**5 Remote Control – Fundamentals .....5.1**

## 5 Remote Control – Fundamentals

Rohde & Schwarz recommends to utilize the VXI Plug & Play Driver for the remote control of R&S NRP power sensors. This driver can be found on the CD-ROM supplied with the sensor or downloaded in its most recent version via the internet (<http://rohde-schwarz.com/>).

The old remote control interface provided by the *Dynamic Link Library NrpControl.dll* is not developed further, but remains on the CD-ROM and can be downloaded via the internet.

## Table of Contents

<b>6 Remote Control – Commands</b> .....	6.1
<b>Notation</b> .....	6.1
<b>Commands as per IEEE 488.2</b> .....	6.2
*IDN? – Identification Query .....	6.2
*RST – Reset .....	6.2
*TRG – Trigger.....	6.2
*TST? – Self Test Query.....	6.2
<b>SCPI Commands</b> .....	6.3
CALibration .....	6.3
CALibration:DATA[?] <calibration data set as <i>definite length block</i> > .....	6.3
CALibration:DATA:LENGth?.....	6.3
CALibration:ZERO:AUTO[?] OFF   ON   ONCE .....	6.3
SENSe (Sensor Configuration).....	6.5
SENSe:AVERAge:COUNt[?] 1 to 65536.....	6.7
SENSe:AVERAge:COUNt:AUTO[?] OFF   ON   ONCE.....	6.7
SENSe:AVERAge:COUNt:AUTO:MTIMe[?] 0.01 to 999.99 .....	6.7
SENSe:AVERAge:COUNt:AUTO:NSRatio[?] 0.0 to 1.0 .....	6.8
SENSe:AVERAge:COUNt:AUTO:RESolution[?] 1 to 4 .....	6.8
SENSe:AVERAge:COUNt:AUTO:SLOT[?] 1 to <SENSe:POWer:TSLot:AVG:COUNt>.....	6.8
SENSe:AVERAge:COUNt:AUTO:TYPE[?] RESolution   NSRatio.....	6.8
SENSe:AVERAge:RESet .....	6.9
SENSe:AVERAge:STATe[?] OFF   ON .....	6.9
SENSe:AVERAge:TCONtrol[?] MOVing   REPeat.....	6.9
SENSe:CORRection:DCYClE[?] 0.001 to 99.999.....	6.9
SENSe:CORRection:DCYClE:STATe[?] OFF   ON .....	6.10
SENSe:CORRection:OFFSet[?] –200.0 to 200.0 .....	6.10
SENSe:CORRection:OFFSet:STATe[?] OFF   ON .....	6.10
SENSe:CORRection:SPDeVice:STATe[?] OFF   ON .....	6.10
SENSe:FREQUency[?] 10.0e6 to 8.0e9/18.0e9/33.0e9 .....	6.11
SENSe:FUNcTION[?] <sensor_function>.....	6.11
SENSe:POWer:AVG:APERture[?] 10.0e–6 to 0.3 .....	6.12
SENSe:POWer:AVG:BUFFer:SIZE[?] 1 to 1024.....	6.13
SENSe:POWer:AVG:BUFFer:STATe[?] OFF   ON .....	6.13
SENSe:POWer:AVG:SMOothing:STATe[?] OFF   ON.....	6.13
SENSe:POWer:BURSt:DTOLerance[?] 0.0 to 0.003 .....	6.14
SENSe:POWer:TSLot:AVG:COUNt[?] 1 to 128 .....	6.14
SENSe:POWer:TSLot:AVG:WIDTh[?] 10.0e–6 to 0.1.....	6.14
SENSe:RANGe[?] 0 to 2 (1 for R&S NRP-Z211/221) .....	6.15
SENSe:RANGe:AUTO[?] OFF   ON .....	6.15
SENSe:RANGe:CLEVel[?] –20.0 to 0.0 .....	6.15
SENSe:SAMPLing[?] FREQ1   FREQ2 .....	6.15
SENSe:SGAMma:CORRection:STATe[?] OFF   ON .....	6.16
SENSe:SGAMma:MAGNitude[?] 0.0 to 1.0.....	6.17

SENSe:SGAMma:PHASe[?]	-360.0 to 360.0	6.17
SENSe:TIMing:EXCLude:STARt[?]	0.0 to 0.1	6.17
SENSe:TIMing:EXCLude:STOP[?]	0.0 to 0.003	6.17
SENSe:TRACe:AVERAge:COUNt[?]	1 to 8192	6.18
SENSe:TRACe:AVERAge:STATe[?]	OFF   ON	6.19
SENSe:TRACe:AVERAge:TCONtrol[?]	MOVing   REPeat	6.19
SENSe:TRACe:MPWidth?		6.19
SENSe:TRACe:OFFSet:TIME[?]	- (<TRIGger:DELay> + 0.005) to 100.0	6.20
SENSe:TRACe:POINts[?]	1 to 1024	6.20
SENSe:TRACe:REALtime[?]	OFF   ON	6.20
SENSe:TRACe:TIME[?]	0.0001 to 0.3	6.20
SYSTem		6.21
SYSTem:INFO? [Item]		6.21
SYSTem:INITialize		6.23
SYSTem:MINPower?		6.23
SYSTem:RUTime[?]	0.0 to 10.0	6.23
SYSTem:SUTime[?]	0.0 to 10.0	6.24
SYSTem:TRANsaction:BEgIn		6.24
SYSTem:TRANsaction:END		6.24
TEST		6.25
TEST:SENSor?		6.25
TRIGger		6.26
ABORt		6.26
INITiate:CONTinuous[?]	OFF   ON	6.26
INITiate:IMMediate		6.27
TRIGger:ATRigger:STATe[?]	OFF   ON	6.27
TRIGger:COUNt[?]	1 to 2 <sup>31</sup>	6.27
TRIGger:DELay[?]	x to 100.0	6.28
TRIGger:DELay:AUTO[?]	OFF   ON	6.28
TRIGger:HOLDoff[?]	0.0 to 10.0	6.28
TRIGger:HYSTeresis[?]	0.0 to 10.0	6.29
TRIGger:IMMediate		6.29
TRIGger:LEVel[?]	x to y	6.29
TRIGger:SLOPe[?]	POSitive   NEGative	6.29
TRIGger:SOURce[?]	HOLD   IMMediate   INTernal   BUS   EXTernal	6.30
<b>List of Remote-Control Commands</b>		6.31

**Figs.**

Fig. 6-1 Effect of *SENSe:POWer:BURSt:DTOLerance* .....6.14

Fig. 6-2 Correction of interactions between the power sensor and the signal source .....6.16

Fig. 6-3 Correction of interactions between the power sensor, the signal source, and the s-parameter device .....6.16

Fig. 6-4 Effect of *SENSe:TIMing:EXCLude:START* and *:STOP* in the *Burst Average* mode .....6.18

Fig. 6-5 Effect of *SENSe:TIMing:EXCLude:START* and *:STOP* in the *Timeslot Average* mode..6.18

**Tables**

Table 6-1 Commands of the *CALibration* system .....6.3

Table 6-2 Commands of the *SENSe* system .....6.5

Table 6-3 Measurement modes .....6.11

Table 6-4 Commands of the *SYSTem* system.....6.21

Table 6-5 Meaning of *Item* in the *SYSTem:INFO?* command .....6.21

Table 6-6 Commands of the *TEST* system .....6.25

Table 6-7 Commands of the *TRIGger* system .....6.26

Table 6-8 List of remote-control commands.....6.31

## 6 Remote Control – Commands

### Notation

In the following sections, all commands implemented in the sensor are first listed in a table according to command systems and are then described in detail. The notation is largely in line with the SCPI standard.

**Command tables** For a quick overview of available commands, the commands are listed in a table before they are described. These tables contain the following four columns:

Command:	Commands and their tree structure.
Parameters:	Possible parameters.
Unit:	The basic unit of the physical parameters (must not be sent with parameters).
Remarks:	Identification of all commands <ul style="list-style-type: none"> <li>• that have no query form</li> <li>• that are available as query only</li> </ul>

**Indentations** The various levels of the SCPI command hierarchy are shown in the table by indentations to the right. The lower the level, the greater the indentation to the right. It should be noted that the complete notation of the command includes the higher levels too.

**Example:**

*SENSe:AVERage:COUNT* is represented in the table as follows:

```
SENSe      first level
  :AVERage  second level
    :COUNT third level
```

In the individual description, the command is shown in full length. An example of the command is given at the end of the description.

[?]  
?

A question mark in square brackets at the end of a command indicates that this command can either be used as a setting command (without question mark) or as a query (with question mark). If the question mark is not in square brackets, the command is a query only.

**Example:**

*SENSe:POWer:AVG:APERture[?]*

*SENSe:POWer:AVG:APERture 1e-3* sets the length of the sampling window to 1 ms.

*SENSe:POWer:AVG:APERture?* Returns the currently set length as a response.

*\*IDN?* Queries the sensor identification string that of course cannot be changed. For this reason, this command is only available as a query.

**Special characters | for parameters**

A vertical bar between parameters is used to separate alternative options (OR link).

**Example:**

*INITiate:CONTinuous OFF | ON*

The parameter *OFF* or *ON* can be entered.

**{numeric expression}**

A numeric expression in braces means that it has been rounded to the nearest integral value.

**<parameter>  
<variable>**

A parameter or a variable in triangular brackets expresses its current value.

## Commands as per IEEE 488.2

The sensor supports a subset of the possible setting commands and queries (*Common Commands and Queries*) in line with IEEE 488.2.

### **\*IDN? – Identification Query**

*\*IDN?* returns a string with information on the sensor's identity (device identification code). In addition, the version number of the installed firmware is indicated. The string for a sensor of type R&S NRP-Z21 has the following structure:

*ROHDE&SCHWARZ,NRP-Z21,<serial number>,<firmware version>*

*<serial number>*: Serial number in ASCII

*<firmware version>*: Firmware version number in ASCII

### **\*RST – Reset**

*\*RST* sets the sensor to the default state, i.e. the default settings for all test parameters are loaded.

### **\*TRG – Trigger**

*\*TRG* triggers a measurement. For this purpose, the sensor is in the *WAIT\_FOR\_TRIGGER* state and the source for the trigger event is set to *BUS (TRIGger:SOURce BUS)*.

### **\*TST? – Self Test Query**

*\*TST?* starts a selftest and returns 0 (no error found) or 1 (an error has occurred). The selftest comprises the following functions:

- RAM test
- Operating voltages
- Temperature measurement
- Calibration data set
- Noise
- Zero-point offsets.



## SCPI Commands

The sensor R&S NRP-Z11/21/31/41/61/211/221 is controlled via the groups of commands

- CALibration (zeroing)
- SENSE (measurement configurations)
- SYSTem
- TRIGger
- SERVICE.

## CALibration

Table 6-1 Commands of the CALibration system

Command	Parameter	Unit	Remarks
CALibration			
:DATA[?]	<calibration data set as definite length block>		
:LENGth?		Bytes	Query only
:ZERO			
:AUTO[?]	OFF   ON   ONCE		

### CALibration:DATA[?] <calibration data set as *definite length block*>

*CALibration:DATA* is used for writing a calibration data set in the flash memory of the sensor.

The query yields the calibration data set currently stored in the flash memory as a *definite length block*.

### CALibration:DATA:LENGth?

*CALibration:DATA:LENGth?* yields the length in bytes of the calibration data set currently stored in the flash memory. Programs that read out the calibration data set can use this information to determine the capacity of the buffer memory required.

### CALibration:ZERO:AUTO[?] OFF | ON | ONCE

The commands *CALibration:ZERO:AUTO ON* and *CALibration:ZERO:AUTO ONCE* zeroes the three measurement paths of the sensor. For this purpose, the test signal must be deactivated or the sensor disconnected from the signal source. The sensor automatically detects the presence of any significant power to be measured. This causes zeroing to be aborted and error message *NRPEROR\_CALZERO* to be output. The *CALibration:ZERO:AUTO OFF* is ignored. Zeroing takes four seconds at a minimum, but at least as long as the selected averaging filter needs for settling (only fixed-filter mode).



#### Repeat zeroing

- during warm-up after switching on or connecting the instrument
- after a substantial variation of the ambient temperature
- after fastening the sensor to an RF connector at high temperature
- after several hours of operation
- when very low-power signals are to be measured, e.g. less than 10 dB above the lower measurement limit.

*For zeroing switch off the test signal and do not remove the sensor from the signal source. Apart from keeping the thermal balance, this has the advantage that the noise superimposed on the test signal (e.g. from a broadband amplifier) can be detected on zeroing and does not impair the measurement result.*

The query always yields 1 (= OFF).

#### Default setting

After a power-on reset, the zero offsets determined during the last calibration are used until the first zeroing. Therefore, very slight zero offsets are to be expected with a warmed up sensor. Initialization by means of \*RST or SYSTem:INITialize has no influence on the current zero offsets.

**SENSe (Sensor Configuration)**

The sensor is configured by means of the commands of the groups *SENSe* and *TRIGger*.

Table 6-2 Commands of the *SENSe* system

Command	Parameter	Unit	Remarks
SENSe			
:AVERage			
:COUNt[?]	1 to 65536		
:AUTO[?]	OFF   ON   ONCE		
:MTIME[?]	0.01 to 999.99	s	
:NSRatio[?]	0.0 to 1.0	dB	
:RESolution[?]	1 to 4		
:SLOT[?]	1 to <SENSe:POWer:TSLot:AVG:COUNt>		
:TYPE[?]	RESolution   NSRatio		
:RESet			No query
:STATE[?]	OFF   ON		
:TCONtrol[?]	MOVing   REPeat		
:CORRection			
:DCYCLE[?]	0.001 to 99.999	%	
:STATE[?]	OFF to ON		
:OFFSet[?]	-200.0 to 200.0	dB	
:STATE[?]	OFF to ON		
:SPDevice:STATE[?]	OFF to ON		
:FREQuency[?]	10.0e6 to 8.0e9 (NRP-Z11/211) or 10.0e6 to 18.0e9 (NRP-Z21/221) or 10.0e6 to 33.0e9 (NRP-Z31) or 10.0e6 to 40.0e9 (NRP-Z41) or 10.0e6 to 50.0e9 (NRP-Z61)	Hz	
:FUNction[?]	"POWer:AVG"   "POWer:TSLot:AVG"   "POWer:BURSt:AVG"   "XTIME:POWer"		
:POWer			
:AVG			
:APERture[?]	10.0e-6 to 0.3	s	

Command	Parameter	Unit	Remarks
:BUFFer			
:SIZE[?]	1 to 1024		
:STATe[?]	OFF   ON		
:SMOothing:STATe[?]	OFF   ON		
:BURSt:DTOLerance[?]	0.0 to 3.0e-3	s	
:TSLot:AVG			
:COUNt[?]	1 to 128		
:WIDTh[?]	10.0e-6 to 100e-3	s	
:RANGe [?]	0 to 2 (NRP-Z11/21/31/41/61) or 0 to 1 (NRP-Z211/221)		
:AUTO[?]	OFF   ON		
:CLEVel[?]	-20.0 to 0.0	dB	
:SAMPling[?]	FREQ1   FREQ2		
:SGAMma			
:CORRection:STATe[?]	OFF   ON		
:MAGNitude[?]	0.0 to 1.0		
:PHASe[?]	-360.0 to 360.0	degree	
:TIMing			
:EXCLude			
:STARt[?]	0.0 to 0.1	s	
:STOP[?]	0.0 to 0.003	s	
:TRACe			
:AVERAge			
:COUNt[?]	1 to 8192		
:STATe[?]	OFF   ON		
:TCONtrol[?]	MOVing   REPeat		
:MPWidth?		s	Query only
:OFFSet:TIME[?]	- (<TRIGger:DELay> + 0.005) to 100.0	s	
:POINts[?]	1 to 1024		

Command	Parameter	Unit	Remarks
:REALtime[?]	OFF   ON		
:TIME[?]	0.0001 to 0.3		

### SENSe:AVERage:COUNT[?] 1 to 65536

*SENSe:AVERage:COUNT* sets the number of measured values that have to be averaged for forming the measurement result in the modes *Continuous Average*, *Burst Average* and *Timeslot Average*. The higher this averaging factor, the less the measured values fluctuate and the longer the measurement time lasts. The parameter is rounded off to the nearest power-of-two number.

The query yields the averaging factor used in the modes *Continuous Average*, *Burst Average* and *Timeslot Average*.



The averaging function must be activated with *SENSe:AVERage:STATe ON* so that the set averaging factor becomes effective.

**Default setting:** 4

### SENSe:AVERage:COUNT:AUTO[?] OFF | ON | ONCE

*SENSe:AVERage:COUNT:AUTO* activates (auto-averaging) or deactivates (fixed-filter mode) automatic determination of the averaging factor in the modes *Continuous Average*, *Burst Average* and *Timeslot Average*. If auto-averaging is activated, the averaging factor is continuously determined and set depending on the level of power and other parameters.

*SENSe:AVERage:COUNT:AUTO ON* activates auto-averaging and *SENSe:AVERage:COUNT:AUTO OFF* deactivates it. On deactivation, the previous, automatically determined averaging factor is used in the fixed-filter mode. The *SENSe:AVERage:COUNT:AUTO ONCE* command ensures that a new averaging factor is determined by the filter automatic function under the current measurement conditions and used in the fixed-filter mode.

The query yields

- 1 for *OFF*,
- 2 for *ON*.

**Default setting:** *ON*

### SENSe:AVERage:COUNT:AUTO:MTIME[?] 0.01 to 999.99

*SENSe:AVERage:COUNT:AUTO:MTIME* sets an upper limit for the settling time of the auto-averaging filter in the *NSRatio* mode and thus limits the length of the filter.

The query returns the time that has been set.

**Default setting:** 4.0 [s]

**SENSe:AVERAge:COUNT:AUTO:NSRatio[?] 0.0 to 1.0**

*SENSe:AVERAge:COUNT:AUTO:NSRatio* determines the relative noise component in the measurement result for the *Continuous Average*, *Burst Average* and *Timeslot Average* modes if auto-averaging is operated in the corresponding mode (*SENSe:AVERAge:COUNT:AUTO:TYPE NSRatio*). The noise component is defined as the magnitude of the level variation in dB caused by the inherent noise of the sensor (two standard deviations).

The query yields the relative noise component in the result for the *Continuous Average*, *Burst Average* or *Timeslot Average* modes.

**Default setting:** 0.01 [dB]

**SENSe:AVERAge:COUNT:AUTO:RESolution[?] 1 to 4**

*SENSe:AVERAge:COUNT:AUTO:RESolution* sets the resolution index for the automatic averaging filter in the *Continuous Average*, *Burst Average* and *Timeslot Average* modes if it is operated in the *RESolution* mode. The resolution index equals the number of decimal places that have to be taken into account for the further processing of the measurement result in dBm, dB $\mu$ V or dB. The normal mode is designed in a similar manner as for the predecessors R&S NRVS and R&S NRVD or other commercial power meters. The higher the selected index, the better the measurement result is filtered without the last significant place (0.01 dB with an index of 3) actually being set. The *NSRatio* setting is recommended instead.

The query yields the resolution index for the *Continuous Average*, *Burst Average* and *Timeslot Average* modes.

**Default setting:** 3

**SENSe:AVERAge:COUNT:AUTO:SLOT[?] 1 to <SENSe:POWer:TSLot:AVG:COUNT>**

*SENSe:AVERAge:COUNT:AUTO:SLOT* defines the timeslot, whose power is referenced by auto-averaging in the *Timeslot Average* mode. The timeslot is addressed via its number, the counting beginning with 1. The timeslot number must not exceed the number of the currently set timeslots. If a valid timeslot number is initially set and then the number of timeslots reduced to a value that is smaller than the initial timeslot number, the initial value is automatically set to the new timeslot number, i.e. auto-averaging references the most recent timeslot.

The query yields the number of the current timeslot, whose power is referenced by auto-averaging in the *Timeslot Average* mode.

**Default setting:** 1

**SENSe:AVERAge:COUNT:AUTO:TYPE[?] RESolution | NSRatio**

*SENSe:AVERAge:COUNT:AUTO:TYPE* defines the automatic averaging filter mode in the *Continuous Average*, *Burst Average* and *Timeslot Average* modes. The *RESolution* parameter sets the mode usual for power meters; *NSRatio* predefines the compliance to an exactly defined noise component.

The query yields

- 1 for *RESolution*,
- 2 for *NSRatio*.

**Default setting:** *RESolution*

## SENSe:AVERage:RESet

*SENSe:AVERage:RESet* initializes the averaging filter for the *Continuous Average*, *Burst Average* or *Timeslot Average* modes. This is useful if a high averaging factor is set in the *SENSe:AVERage:TCONtrol MOVing* filter mode and if the power to be measured has significantly decreased since the previous measurement, e.g. by several powers of ten. In this case, previous measurement results still contained in the averaging filter strongly affect the settling of the display; as a result, the advantage of the *SENSe:AVERage:TCONtrol MOVing* filter mode, i.e. the ability to detect trends in the measurement result while the measurement is still in progress, is lost. The *SENSe:AVERage:RESet* command solves this problem by deleting all previous measurement results that the averaging filter contains. After initialization, the filter length gradually increases from 1 to its nominal value *SENSe:AVERage:COUNt*, so that trends in the measurement result become quickly apparent. However, this procedure does not shorten the measurement time required in order for the averaging filter to settle completely.

## SENSe:AVERage:STATe[?] OFF | ON

*SENSe:AVERage:STATe* switches on or off the averaging filter for the *Continuous Average*, *Burst Average* and *Timeslot Average* modes.

The query yields

- 1 for *OFF*,
- 2 for *ON*.

**Default setting:** *ON*

## SENSe:AVERage:TCONtrol[?] MOVing | REPEAT

*SENSe:AVERage:TCONtrol* (*terminal control*) defines the behaviour of the averaging filter in the *Continuous Average*, *Burst Average* and *Timeslot Average* modes. As soon as a new measured value is shifted to the FIR filter, a new average value is available at the filter output, which is obtained from the new measured value and the other values stored in the filter.

The *MOVing* parameter defines that each new average value is output as a measurement result. This allows tendencies in the result to be recognized during the measurement procedure.

The *REPEAT* parameter defines that a new result is output after the FIR filter has been filled with new measured values. This ensures that no redundant information is output.

The query yields

- 1 for *MOVing*,
- 2 for *REPEAT*.

**Default setting:** *REPEAT*

## SENSe:CORRection:DCYClE[?] 0.001 to 99.999

*SENSe:CORRection:DCYClE* sets the duty cycle to a percent value for the correction of pulse-modulated signals. With the correction activated, the sensor calculates the signal pulse power from this value and the mean power. Since the duty cycle is only useful in the *Continuous Average* mode, it is evaluated only there.

The query yields the current duty cycle in percent.

**Default setting:** 1.0 [%]

**SENSe:CORRection:DCYClE:STATe[?] OFF | ON**

*SENSe:CORRection:DCYClE:STATe ON* activates the duty cycle correction and thus the pulse-power measurement whereas *SENSe:CORRection:DCYClE:STATe OFF* deactivates it.

The query yields

- 1 for *OFF*,
- 2 for *ON*.

**Default setting:** *OFF*

**SENSe:CORRection:OFFSet[?] -200.0 to 200.0**

*SENSe:CORRection:OFFSet* defines a fixed offset in dB, which is used to correct the measured value. (When a log scale is used, the offset is added to the measured value; this is the reason why the command has this name.)

The attenuation of an attenuator located ahead of the sensor or the coupling attenuation of a directional coupler is taken into account with a positive offset, i.e. the sensor calculates the power at the input of the attenuator or directional coupler. A negative offset can be used to correct the influence of a gain connected ahead.

The query yields the set offset in dB.

**Default setting:** *0.0 [dB]*

**SENSe:CORRection:OFFSet:STATe[?] OFF | ON**

*SENSe:CORRection:OFFSet:STATe ON* activates the offset correction and *SENSe:CORRection:OFFSet:STATe OFF* deactivates it.

The query yields

- 1 for *OFF*,
- 2 for *ON*.

**Default setting:** *OFF*

**SENSe:CORRection:SPDeVice:STATe[?] OFF | ON**

*SENSe:CORRection:SPDeVice:STATe ON* activates the s-parameter data set for a component (attenuator, directional coupler) connected ahead of the sensor. Parameter *OFF* deactivates it.

The use of s-parameters instead of a fixed offset (see group of commands *SENSe:CORRection:OFFSet*) allows more precise measurements, since the interactions between the sensor, the source and components connected between them can be taken into account. (For detailed information on loading s-parameter data sets, refer to section 3.) The sensor has no factory-set s-parameter data set. In this state, the *SENSe:CORRection:SPDeVice:STATe ON* command generates an error message.

The query yields

- 1 for *OFF*,
- 2 for *ON*.

**Default setting:**

The factory-set default setting of the sensor is *OFF*. On loading an s-parameter table, the default setting can be redefined (see section 3).



**SENSe:FREQuency[?] 10.0e6 to 8.0e9/18.0e9/33.0e9/40.0e9/50.0e9**

*SENSe:FREQuency* transfers the carrier frequency of the RF signal to be measured; this frequency is used for the frequency-response correction of the measurement result. The center frequency is set for broadband signals (spread-spectrum signals, multicarrier signals).

The query yields the set carrier frequency in Hz.

**Default setting:** 50.0e6 [Hz]

**SENSe:FUNction[?] <sensor\_function>**

*SENSe:FUNction* <sensor\_function> sets the sensor to one of the following measurement modes:

Table 6-3 Measurement modes

<sensor_function>	Description of the measurement mode
"POWer:AVG"	<p><b>Continuous Average</b></p> <p>In this mode, the average power of the measurement signal is asynchronously measured within definable time intervals (sampling windows). The width of a sampling window is set with the <i>SENSe:POWer:AVG:APERture</i> command. The measurements are performed with chopper stabilization to obtain more accurate measurement results with reduced noise and zero offset. Therefore, a single measurement is always performed over two sampling windows, the polarity of the detector output signal being reversed for the second window. By taking the difference of the output signals, the effect of the video path on noise and zero drift is minimized. When the averaging function is activated, the averaging factor determines how often the described measurement cycle is repeated.</p> <p>A measurement should be started with the command <i>INITiate:IMMEDIATE</i> (once) or <i>INITiate:CONTinuous ON</i> (continuously), the trigger source being set to <i>IMMEDIATE</i> with the <i>TRIGger:SOURce</i> command (asynchronous measurement).</p>
"POWer:TSLot:AVG"	<p><b>Timeslot Average</b></p> <p>The average power of a definable number of successive timeslots within a frame structure with equal spacing is measured. The width of one slot must be defined with <i>SENSe:POWer:TSLot[:AVG]:WIDTH</i>; the number of slots is defined by <i>SENSe:POWer:TSLot[:AVG]:COUNT</i>. It is essential to define the parameter <i>TRIGger:DELay</i> to ensure that the beginning of the first slot to be measured coincides with the delayed trigger point. The measurement result is an array with the same number of elements as timeslots. Each element represents the average power in a particular timeslot.</p> <p>To minimize noise and zero offset, the measurement is performed with chopper stabilization. The polarity of the detector output signal is therefore reversed from frame to frame. By subsequently taking the difference of the output signals, the effect of the video path on noise and zero drift is reduced.</p> <p>Time intervals that are to be excluded from the measurement can be set at the beginning and end of each timeslot (see commands <i>SENSe:TIMing:EXCLude:START</i> and <i>SENSe:TIMing:EXCLude:STOP</i>).</p> <p>A measurement is initiated with the command <i>INITiate:IMMEDIATE</i> (once, irrespective of the number of repetitions required for averaging) or <i>INITiate:CONTinuous ON</i> (continuously). The trigger source must be set to <i>INTernal</i> or <i>EXTernal</i> with the <i>TRIGger:SOURce</i> command. After each occurrence of a trigger event, the power is measured sequentially in all timeslots. Note that a trigger event must be available for each frame.</p>

<sensor_function>	Description of the measurement mode
"POWer:BURSt:AVG"	<p><b>Burst Average</b></p> <p>This mode is used to measure the average power of bursts. The time interval in which the average power is measured starts when the power exceeds the trigger threshold and stops when the trigger logic detects the end of the pulse. To prevent power drops due to modulation from being erroneously interpreted as the end of a pulse, the user must define the dropout tolerance with <i>SENSe:POWer:BURSt:DTOLerance</i>.</p> <p>To minimize noise and zero offset, the measurement is performed with chopper stabilization. The polarity of the detector output signal is therefore reversed from burst to burst. By subsequently taking the difference of the output signals, the effect of the video path on noise and zero drift is minimized.</p> <p>In the <i>Burst Average</i> mode, only internal trigger events (from the signal) are evaluated (irrespective of the setting of the <i>TRIGger:SOURce</i> parameter). The <i>TRIGger:DELay</i> parameter is also ignored, so that the measurement interval begins exactly when the signal exceeds the trigger threshold.</p> <p>Time intervals that are to be excluded from the measurement can be set at the beginning and at the end of the measurement interval (see commands <i>SENSe:TIMing:EXCLude:STARt</i> and <i>SENSe:TIMing:EXCLude:STOP</i>).</p>
"XTIME:POWer"	<p><b>Trace</b></p> <p>In the <i>Trace</i> mode, the envelope power can be recorded as a function to time. This is done by sampling power over a time interval that can be specified by the user (<i>SENSe:TRACe:OFFSet:TIME</i> and <i>SENSe:TRACe:TIME</i> commands), and then assigning the power values that have been determined to a number of pixels that are largely user-selectable (<i>SENSe:TRACe:POINts</i> command). The time interval represented by a pixel is obtained by dividing the trace length by N-1, where N is the number of pixels.</p> <p>In the simplest case, each pixel is assigned a single sampling value which fully characterizes it. If several sampling values are assigned to a pixel, the average power is made available for the time interval in question.</p> <p>In the <i>SENSe:TRACe:REALtime ON</i> setting (realtime processing), the measurement is performed without chopper stabilization, i.e. a measurement consists of a single sampling sequence activated by a trigger event, independent of the setting of the averaging filter. Otherwise a second sampling sequence with reversed polarity of the detector output voltage is recorded, and the difference of the measured values of the two sampling sequences is determined for each pixel. This suppresses low-frequency noise and increases the measurement accuracy for the average power of the individual pixels. The averaging factor determines how often the cycle is repeated.</p>

Time intervals that are excluded from the measurement can be set at the beginning and the end of the sampling window or timeslot in the measurement modes *Burst Average* and *Timeslot Average*. (*SENSe:TIMing:EXCLude:STARt* and *-:STOP*).

The query yields

- 1 for "POWer:AVG",
- 2 for "POWer:TSLot:AVG",
- 4 for "POWer:BURSt:AVG",
- 8 for "XTIME:POWer".

**Default setting:** "POWer:AVG"

### **SENSe:POWer:AVG:APERture[?] 10.0e-6 to 0.3**

*SENSe:POWer:AVG:APERture* defines the time interval (sampling window) for the *Continuous Average* mode; measured values are continuously recorded in this interval. In manual operation, the default setting of 20 ms in conjunction with the activated smoothing is sufficient in most cases.

Larger sampling windows are needed when the measurement shows fluctuations due to modulation. It is then useful to adapt the size of the sampling window exactly to the modulation period, which yields an optimally stable display. If the modulation period varies or is not precisely known, the *Smoothing* function should also be activated (see command group *SENSe:POWer:AVG:SMOothing*). With smoothing activated, approx. 5 periods within a sampling window are sufficient to reduce the fluctuations caused by modulation to an acceptable degree; fluctuations are no longer perceptible with

more than 9 periods. With smoothing deactivated, the situation is considerably more unfavorable. In this case, 300 instead of 5 periods are required, and the fluctuations do not disappear completely until there are 3000 or more periods.

The query yields the currently set width of the sampling window in seconds.

**Default setting:** 0.02 [s]

### **SENSe:POWer:AVG:BUFFer:SIZE[?] 1 to 1024**

*SENSe:POWer:AVG:BUFFer:SIZE* sets the buffer size for the buffered *Continuous Average* mode.

The query yields the current buffer size for the buffered *Continuous Average* mode.

**Default setting:** 1

### **SENSe:POWer:AVG:BUFFer:STATe[?] OFF | ON**

The buffered *Continuous Average* mode is activated with *ON* and deactivated with *OFF*. In this mode, the results generated by trigger events are collected in the sensor until the buffer is filled. All results are then transferred as block data. The measurement rate obtained is thus higher than in the non-buffered *Continuous Average* mode. The maximum measurement rate is obtained by combining the buffered mode with multiple triggering (see parameter *TRIGger:COUNt*). The size of the result buffer is set with the *SENSe:POWer:AVG:BUFFer:SIZE* command.

The query yields

- 1 for *OFF*,
- 2 for *ON*.

**Default setting:** *OFF*

### **SENSe:POWer:AVG:SMOothing:STATe[?] OFF | ON**

The *ON* parameter activates a smoothing filter for modulated signals in the *Continuous Average* mode and *OFF* deactivates it. The smoothing filter is a steep-edge digital lowpass filter used to suppress variations of results caused by low-frequency modulation. This parameter should be activated to reduce variations in results due to modulation when the size of the sampling window cannot or should not be exactly adapted to the modulation period. If the selected sampling window is 5 to 9 times larger than a modulation period, the variations in display are normally sufficiently reduced. With smoothing deactivated, 300 to 3000 periods are required to obtain the same effect.

With smoothing deactivated, the sampling values are considered equivalent and averaged in a sampling window, which yields an integrating behaviour of the measuring instrument. As described above, optimum suppression of variations in the result is thus obtained when the size of the sampling window is exactly adapted to the modulation period. Otherwise, the modulation can have a considerable influence, even if the sampling window is much larger than the modulation period. The behaviour can be considerably improved by subjecting sampling values to weighting (raised-von-Hann window), which corresponds to video filtering. This is exactly what happens with activated smoothing.

Since the smoothing filter increases the inherent noise of the sensor by approx. 20%, it should remain deactivated if it is not required.

The query yields

- 1 for *OFF*,
- 2 for *ON*.

**Default setting:** *OFF*

**SENSe:POWer:BURSt:DTOLerance[?] 0.0 to 0.003**

*SENSe:POWer:BURSt:DTOLerance* defines the dropout tolerance, a parameter for reliably detecting the burst end in the *Burst Average* mode with modulated signals (e. g. with digital standards NADC, PDC, PHS, etc.). The dropout tolerance should be selected larger than the longest amplitude drop and smaller than the gap between two consecutive bursts. The default value is sufficient for all usual digital communication standards.

The query yields the dropout tolerance for the *Burst Average* mode.

**Default setting:** 0.0001 [s]

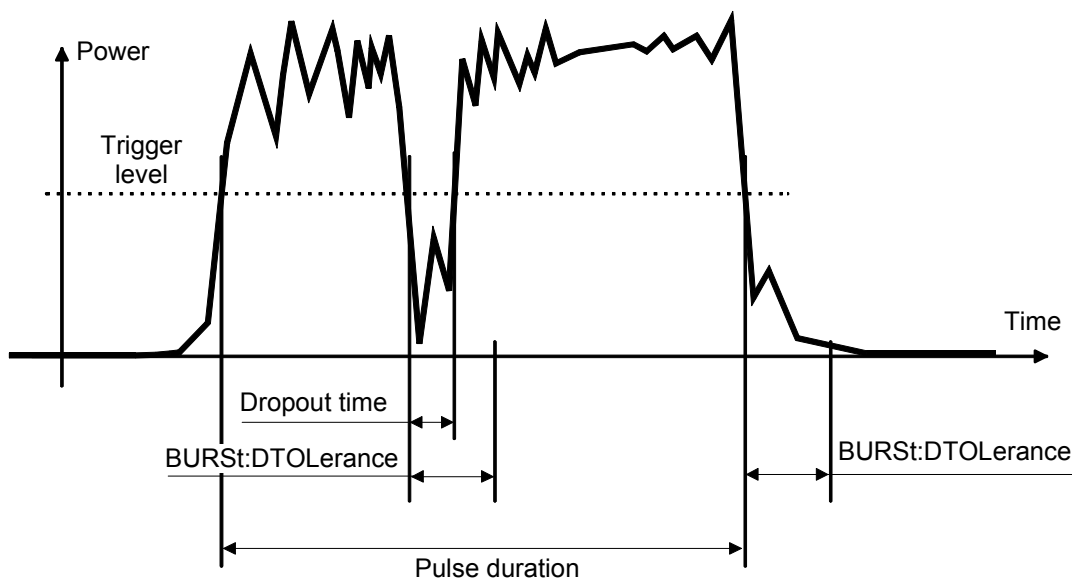

Fig. 6-1 Effect of *SENSe:POWer:BURSt:DTOLerance*

**SENSe:POWer:TSLot:AVG:COUNT[?] 1 to 128**

For the Timeslot mode, *SENSe:POWer:TSLot:AVG:COUNT* sets the number of consecutive timeslots that are to be processed after each trigger event.

The query yields the number of consecutive timeslots.

**Default setting:** 8

**SENSe:POWer:TSLot:AVG:WIDTh[?] 10.0e-6 to 0.1**

*SENSe:POWer:TSLot:AVG:WIDTh* sets the length of a timeslot for the *Timeslot Average* mode (in s).

The query yields the length of a timeslot for the *Timeslot Average* mode.

**Default setting:** 0.001 [s]

**SENSe:RANGe[?] 0 to 2 (1 for R&S NRP-Z211/221)**

*SENSe:RANGe* selects the measurement path of the sensor.

The power sensor R&S NRP-Z11/21/31/41/61 has three separate measurement paths. Path 1 is the most sensitive, path 2 medium and path 3 the least sensitive. *SENSe:RANGe 0* selects path 1, *SENSe:RANGe 1* path 2 and *SENSe:RANGe 2* path 3.

The power sensor R&S NRP-Z211/221 has two separate measurement paths. Path 1 is the more sensitive, path 2 the less sensitive. *SENSe:RANGe 0* selects path 1, *SENSe:RANGe 1* selects path 2.

The dynamic ranges of these measurement paths depend on frequency and temperature and are model-specific. Reference values are:

- (R&S NRP-Z11/21/31/41/61)  
40  $\mu$ W (–14 dBm) for the most sensitive measurement path, 4 mW (6 dBm) for the medium one and 400 mW (26 dBm) for the least sensitive;
- (R&S NRP-Z211/221)  
380  $\mu$ W (–4.2 dBm) for the more sensitive measurement path and 190 mW (22.8 dBm) for the less sensitive one.

The query yields

- 0 for path 1,
- 1 for path 2,
- 2 for path 3.

If the measurement path is selected manually (*SENSe:RANGe:AUTO OFF*), the currently selected measurement path is output. With automatic selection, the last path that was set manually is output. Since this setting has been saved, it is immediately reset after deactivating the automatic function.

**Default setting:** 2 (NRP-Z11/21/31/41/61, least sensitive path) or  
1 (NRP-Z211/221, less sensitive path)

**SENSe:RANGe:AUTO[?] OFF | ON**

*SENSe:RANGe:AUTO ON* activates the automatic selection of the measurement path and *SENSe:RANGe:AUTO OFF* deactivates it.

The query yields

- 1 for *OFF*,
- 2 for *ON*.

**Default setting:** *ON*

**SENSe:RANGe:CLeVel[?] –20.0 to 0.0**

*SENSe:RANGe:CLeVel* is used to reduce the transition range between measurement paths 1 and 2 or 2 and 3 by the indicated value (in dB). This can improve the measurement accuracy for signals with a high *peak-to-average* ratio, since the headroom for modulation peaks becomes larger. The disadvantage is that the S/N ratio is reduced at the lower limits of the transition ranges.

The query yields the offset of transition ranges between measurement channels 1 and 2 or 2 and 3.

**Default setting:** 0.0 [dB]

**SENSe:SAMPling[?] FREQ1 | FREQ2**

*SENSe:SAMPling* is used to vary the sampling frequency of the analog-digital converter in the sensor. With parameter specification *FREQ1* the sampling frequency is 134.400 kHz, and 119.467 kHz with

parameter *FREQ2*. This is provided to suppress interfering low-frequency mixture products from signal components and the sampling frequency.

The query yields

- 1 for *FREQ1*,
- 2 for *FREQ2*.

Default setting: *FREQ1*

**SENSe:SGAMma:CORRection:STATe[?] OFF | ON**

*SENSe:SGAMma:CORRection:STATe ON* initiates the use of the complex reflection coefficient  $\Gamma_{source}$  of the signal source defined with *SENSe:SGAMma:MAGNitude* and *SENSe:SGAMma:PHASe* for the correction of interactions between the power sensor and the signal source. This makes it possible to determine the power *P* delivered by the signal source with considerably greater accuracy.

The complex reflection coefficient  $\Gamma_{sensor}$  of the sensor, which is also required for the correction, is prestored in the calibration data memory for a large number of frequencies.

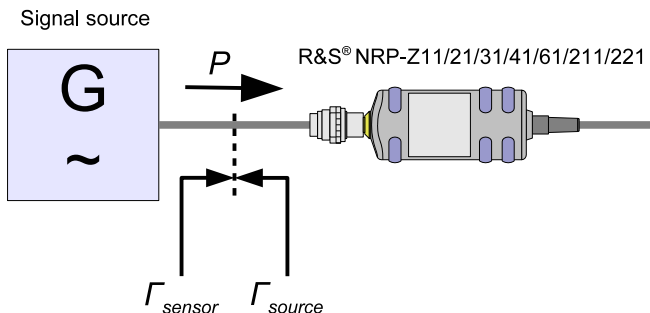

Fig. 6-2 Correction of interactions between the power sensor and the signal source

If the gamma correction is made in connection with an s-parameter correction (setting *SENSe:CORRection:SPDevice:STATe ON*), the interaction of the signal source with the s-parameter device on the one hand and the input of the power sensor on the other hand (depending on the magnitude of the term  $|s_{12} s_{21}|$ ) is corrected. The interaction between the complex reflection coefficient  $\Gamma_{sensor}$  of the power sensor and the parameter  $s_{22}$  is always taken into account when the s-parameter correction is activated – independent of the gamma correction in connection with the signal source.

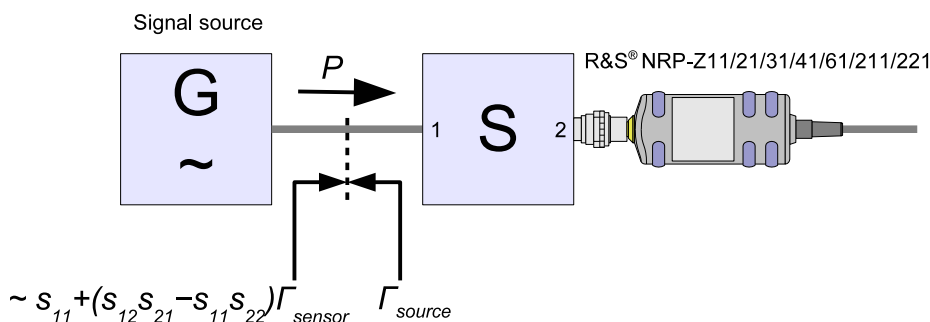

Fig. 6-3 Correction of interactions between the power sensor, the signal source, and the s-parameter device

The query yields

- 1 for OFF,
- 2 for ON.

**Default setting:** OFF

### **SENSe:SGAMma:MAGNitude[?] 0.0 to 1.0**

*SENSe:SGAMma:MAGNitude* defines the magnitude of the complex reflection coefficient of the signal source. A value of 0.0 corresponds to ideal match and a value of 1.0 to total reflection.

The query yields the set magnitude.

**Default setting:** 0.0

### **SENSe:SGAMma:PHASe[?] -360.0 to 360.0**

*SENSe:SGAMma:PHASe* defines the phase angle (in degrees) of the complex reflection coefficient of the signal source.

The query yields the set phase angle.

**Default setting:** 0.0 [°]

### **SENSe:TIMing:EXCLude:STARt[?] 0.0 to 0.1**

*SENSe:TIMing:EXCLude:STARt* defines the exclusion time at the beginning of the measurement window in the *Burst Average* and *Timeslot Average* modes. It is indicated by  $T_{START}$  in Figs. Fig. 6-4 and Fig. 6-5.

The query yields the exclusion time at the beginning of the measurement window.

**Default setting:** 0.0 [s]

### **SENSe:TIMing:EXCLude:STOP[?] 0.0 to 0.003**

*SENSe:TIMing:EXCLude:STOP* defines the exclusion time at the end of the measurement window in the *Burst Average* and *Timeslot Average* modes. It is indicated by  $T_{STOP}$  in Figs. Fig. 6-4 and Fig. 6-5.

The query yields the exclusion time at the end of the measurement window.

**Default setting:** 0.0 [s]

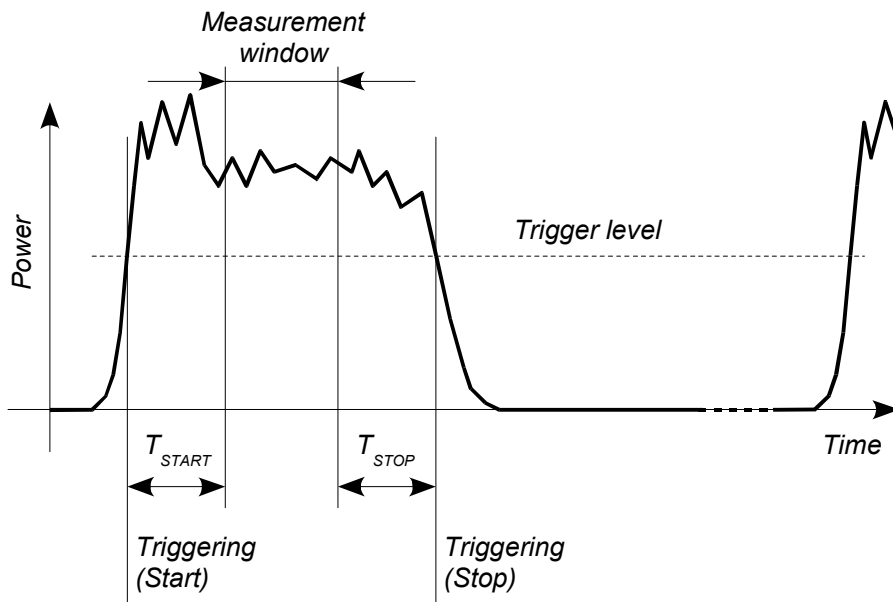

Fig. 6-4 Effect of `SENSe:TIMing:EXCLude:START` and `:STOP` in the *Burst Average* mode

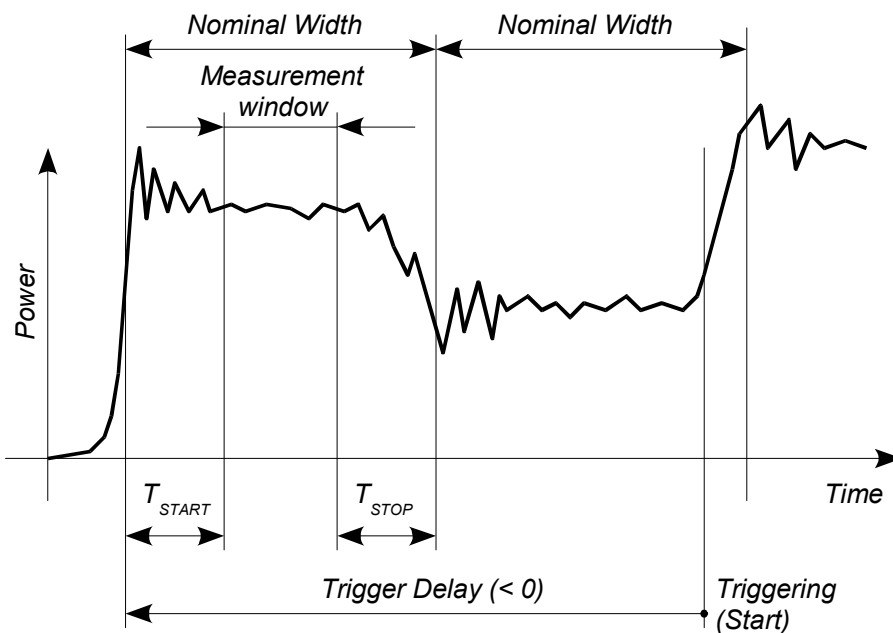

Fig. 6-5 Effect of `SENSe:TIMing:EXCLude:START` and `:STOP` in the *Timeslot Average* mode

**SENSe:TRACe:AVERAge:COUNT[?] 1 to 8192**

`SENSe:TRACe:AVERAge:COUNT` is used to set the averaging factor for the *Trace* mode. To put the setting into effect, you must also activate averaging for the *Trace* mode and deactivate the *Realtime* mode (settings `SENSe:TRACe:AVERAge:STATe ON` and `SENSe:TRACe:REALtime OFF`). When trace averaging is activated, the measurement is always performed with chopper stabilization, i.e. the number of recorded sampling sequences is twice as large as the averaging factor (alternating measurements with reversed and non-reversed polarity). The result is that two sampling sequences are recorded if the averaging factor is 1, eight if the averaging factor is 4, and so forth. If the averaging factor transmitted to the sensor is not a power of two, the parameter is rounded up or off to the next power-of-two number.



The query yields the averaging factor used in the sensor for the *Trace* mode.

**Default setting:** 4

### **SENSe:TRACe:AVERAge:STATe[?] OFF | ON**

*SENSe:TRACe:AVERAge:STATe* switches the averaging filter on or off for the *Trace* mode.

The query yields

- 1 for *OFF*,
- 2 for *ON*.

**Default setting:** *ON*

### **SENSe:TRACe:AVERAge:TCONtrol[?] MOVing | REPeat**

*SENSe:TRACe:AVERAge:TCONtrol* (*terminal control*) defines how the measurement results are to be output in the *Trace* mode if the averaging filter has been activated.

The *REPeat* parameter specifies that a measurement result is not output until the entire measurement has been completed. This means that the number of measurement cycle repetitions is equal to the set averaging factor. If the averaging factor is large, the measurement time can be very long.

When settings are made with the *MOVing* parameter, intermediate values are output to facilitate early detection of changes in the measured quantity. In the settled state – i.e. the number of measurements specified by the averaging factor have been performed – a moving average is output in the *Trace* mode. The *SYStem:RUTime* command can be used to vary the output rate over a wide range so that some intermediate results can be ignored.

The query yields

- 1 for *MOVing*,
- 2 for *REPeat*.

**Default setting:** *REPeat*

### **SENSe:TRACe:MPWidth?**

With *SENSe:TRACe:MPWidth?*, the attainable time resolution can be read out for the *Trace* mode. The readout value is the smallest possible distance between two pixels – in other words, it is the smallest time interval that can be assigned to a pixel. With internal triggering (setting *TRIGger:SOURce INTernal*), this value is 10  $\mu$ s and is thus nearly identical with the reciprocal of the sampling frequency. With external triggering (setting *TRIGger:SOURce EXTernal*), the value can be reduced down to 2.5  $\mu$ s. However, the prerequisite for this is that realtime processing is deactivated (setting *SENSe:TRACe:REALtime OFF*) so that more than one sampling sequence can be recorded. By offsetting the sampling sequences to each other by a certain time (*equivalent time sampling*), the sensor can then attain a better time resolution. The number of repetitions the sensor needs for this is equal to 32 times the averaging factor.

If the user sets a point matrix that is denser than the resolution it corresponds to (10  $\mu$ s or 2.5  $\mu$ s), a value is output for each of these points, but neighboring points may be assigned the same value.

Note: The point matrix to be output is defined by the trace length (setting *SENSe:TRACe:TIME*) and the number of points (setting *SENSe:TRACe:POINTS*).

**SENSe:TRACe:OFFSet:TIME[?] – (<TRIGger:DELay> + 0.005) to 100.0**

*SENSe:TRACe:OFFSet:TIME* is used to specify the start of recording for the *Trace* mode. It is identical with the first pixel. The time associated with the last pixel is the time associated with the first pixel plus the trace length. The start of recording is referenced to the delayed trigger point (settable with the *TRIGger:DELay* command). Negative values indicate that the start of recording occurs before the trigger point.

Due to the hardware limitations of the power sensor, the recording cannot start at any point in time before the physical trigger event, i.e. the sum of the parameters *TRIGger:DELay* and *SENSe:TRACe:OFFSet:TIME* must be limited at the negative end. This limit amounts to –5 ms.

Example: The trigger delay is set to –500  $\mu$ s. This means that the start of recording can be set to occur max. 4.5 ms before the delayed trigger point.

The query yields the start of recording in seconds, referenced to the delayed trigger.

**Default setting:** 0.0 [s]

**SENSe:TRACe:POINTs[?] 1 to 1024**

This command defines the time resolution of the measurement result. Each "point" represents a time interval whose duration is obtained from the trace length (command *SENSe:TRACe:TIME*) divided by  $N-1$ , where  $N$  is the number of "points". The measurement result for a "point" equals the average power over the associated time interval.

The query yields the number of set "points".

**Default setting:** 100

**SENSe:TRACe:REALtime[?] OFF | ON**

*SENSe:TRACe:REALtime ON* activates realtime processing for the *Trace* mode so that single events can also be recorded in this setting. Only one sampling sequence per measurement is recorded. Since the averaging filter of the sensor is not used, the settings made with *SENSe:TRACe:AVERAge:STATE* and *SENSe:TRACe:AVERAge:COUNt* are ignored. However, they remain unchanged, and are thus applied again when realtime processing is deactivated.

The query yields

- 1 for *OFF*,
- 2 for *ON*.

**Default setting:** *OFF*

**SENSe:TRACe:TIME[?] 0.0001 to 0.3**

*SENSe:TRACe:TIME* sets the trace length in the *Trace* mode. This time period is divided into a number of equal intervals, in which the average power is determined. The number of intervals equals the number of test points, which is set with the command *SENSe:TRACe:POINTs*.

The query yields the set length in s.

**Default setting:** 0.01 [s]

## SYSTEM

With the aid of the *SYSTEM* system, administrative device settings can be defined and queried. This includes detailed information on the sensor and its initialization and the transfer of available commands and their parameter limits.

Table 6-4 Commands of the *SYSTEM* system

Command	Parameter	Unit	Remarks
SYSTEM			
:INFO? [Item]			Query only
:INITialize			No query
MINPower?		W	Query only
RUTime[?]	0.0 to 10.0	s	
SUTime[?]	0.0 to 10.0	s	
:TRANsaction			
:BEGIN:			No query
:END			No query

### SYSTEM:INFO? [Item]

*SYSTEM:INFO?* yields a string containing information that is more detailed than the identification string delivered by the sensor as a response to *\*IDN?*. If no *Item* is specified, the response string is a sequence of entries in the form *Item:Information-String* separated by *CR* and *LF* (in C notation:  $\backslash\r\n$ ). With the *Item* optionally appended to the command, the entry for the required *Item* can be queried. The response string is zero-terminated, i.e. its end identification is a zero byte (in C notation:  $\backslash0$ ).

Table 6-5 Meaning of *Item* in the *SYSTEM:INFO?* command

Item	Information string	Remarks
"MANUFACTURER"	"Rohde & Schwarz"	Manufacturer
"TYPE"	e. g. "NRP-Z11" for R&S NRP-Z11	Type designation
"STOCK NUMBER"	"1138.3004.02" for R&S NRP-Z11 "1137.6000.02" for R&S NRP-Z21 "1169.2400.02" for R&S NRP-Z31 "1171.8801.02" for R&S NRP-Z41 "1171.7505.02" for R&S NRP-Z61 "1417.0409.02" for R&S NRP-Z211 "1417.0309.02" for R&S NRP-Z221	Material number
"SERIAL"	"<serial number>"	6-digit serial number

Item	Information string	Remarks
"HWVERSION"	"000000000"	Hardware version (standard)
"HWVARIANT"	"000000000"	Hardware model (standard)
"SW BUILD"	"<build number>"	Version number of sensor firmware
"TECHNOLOGY"	"3 Path Diode"	Detector technology used
"FUNCTION"	"Power Terminating"	The R&S NRP-Z11/21/31/41/61/211/221 is a terminating power sensor.
"MINPOWER"	"<nominal lower test limit in W>"	The nominal lower test limit of the R&S NRP-Z11/21/31/41/61 is 200 pW, i.e. with s-parameter correction deactivated, the sensor returns the information string "2e-10" as a response to <i>SYSTEM:INFO? "MINPOWER"</i> . The nominal lower test limit of the R&S NRP-Z211/221 is 1 nW, i.e. with s-parameter correction deactivated, the sensor returns the information string "1e-9". With s-parameter correction activated, the information string depends on the nominal lower limit of the sensor/twoport combination.
"MAXPOWER"	"<nominal upper test limit in W>"	The nominal upper test limit of the R&S NRP-Z11/21/31/41/61 is 200 mW, i.e. with s-parameter correction deactivated, the sensor returns the information string "0.2" as a response to <i>SYSTEM:INFO? "MAXPOWER"</i> . The nominal upper test limit of the R&S NRP-Z211/221 is 100 mW, i.e. with s-parameter correction deactivated, the sensor returns the information string "0.1". With s-parameter correction activated, the information string depends on the nominal upper limit of the sensor/twoport combination.
"MINFREQ"	"1e+07"	The minimum measuring frequency of the R&S NRP-Z11/21/31/41/61/211/221 is 10 MHz.
"MAXFREQ"	"8e+09" for R&S NRP-Z11/211 "1.8e+10" for R&S NRP-Z21/221 "3.3e+10" for R&S NRP-Z31 "4e+10" for R&S NRP-Z41 "5e+10" for R&S NRP-Z61	The maximum measuring frequency is 8 GHz for the R&S NRP-Z11/211, 18 GHz for the R&S NRP-Z21/221, 33 GHz for the R&S NRP-Z31, 40 GHz for the R&S NRP-Z41, and 50 GHz for the R&S NRP-Z61.
"RESOLUTION"	"2.5µs Ext, 10µs Int"	The maximum time resolution that can be reached in the <i>Trace</i> mode is 2.5 µs for internal triggering and 10 µs for external triggering.
"IMPEDANCE"	"50"	The R&S NRP-Z11/21/31/41/61/211/221 RF input has a nominal input impedance of 50 Ω.
"COUPLING"	"AC/DC"	The RF input of the R&S NRP-Z11/21/31/41/61/211/221 is DC-coupled, but DC voltages superimposed on the RF signal are suppressed by the measurement amplifier.
"CAL. ABS."	"<date>"	Date of absolute calibration in the format YYYY-MM-DD. "Invalid Calibration Date" is returned with an invalid date entry.
"CAL. REFL."	"<date>"	Date of reflection-coefficient calibration in the format YYYY-MM-DD. "Invalid Calibration Date" is returned with an invalid date entry.

Item	Information string	Remarks
"CAL. S-PARA."	"<date>"	Date of s-parameter calibration in the format YYYY-MM-DD. If no S parameter set is loaded, the sensor returns the string "not applicable". "Invalid Calibration Date" is returned with an invalid date entry.
"CAL. MISC."	"<date>"	Date of the calibration of other parameters in the format YYYY-MM-DD. "Invalid Calibration Date" is returned with an invalid date entry.
"CAL. TEMP."	"not applicable"	Temperature response calibration of the R&S NRP-Z11/21/31/41/61/211/221 is neither required nor possible.
"CAL. LIN."	"not applicable"	Linearity calibration of the R&S NRP-Z11/21/31/41/61/211/221 is neither required nor possible.
"SPD MNEMONIC"	"<mnemonic string>"	Clear-text designation of the components connected ahead of the sensor.
"TESTLIMIT"	"0.160 dB"	Test limit for the automated test conducted by the NRP power meter base unit if s-parameter correction has been deactivated.
"TESTLIMIT PD."	"<testlimit>"	Test limit for the automated test conducted by the NRP power meter base unit if s-parameter correction has been activated (actual value dependent on s-parameters of the component connected ahead of the sensor).
"UPTIME"	"<uptime in s>"	Uptime of the power sensor since the last power-up/firmware update in seconds.

## SYSTEM:INITialize

*SYSTEM:INITialize* sets the sensor to the standard state, i.e. the default settings for all test parameters are loaded in the same way as with *\*RST*. The sensor then outputs a complete list of all supported commands and parameters. With the command, the remote-control software can automatically adapt to the features of different types of sensors with different functionality.

## SYSTEM:MINPower?

*SYSTEM:MINPower?* yields the lower test limit of the sensor or the combination comprising the sensor and components connected ahead of it, if the *SENSe:CORRection:SPDevice* parameter has the *ON* value. This query can be used to determine a useful resolution for the result display near the lower test limit.

## SYSTEM:RUTime[?] 0.0 to 10.0

This command is used to limit the output rate of measurements with continuous output of measurement results (setting *INITiate:CONTinuous ON*). This is practical if the measurement time is very short or if intermediate values are output (command *SENSe:AVERage:TCONtrol MOVing* or *SENSe:TRACe:AVERage:TCONtrol MOVing*). Without this limitation, the controlling host can be overloaded very fast or excessively occupied with accepting measured values.

The parameter in the *SYSTEM:RUTime* command is selected so that it equals the desired minimum interval between two measured value outputs. This is equivalent to the reciprocal of the output rate. If the measurement takes longer to begin with, the output rate decreases proportionately.

**Default setting:** 0.1 [s]

### **SYSTEM:SUTime[?] 0.0 to 10.0**

This command is used to reduce the frequency of messages concerning status changes of the sensor from the *WAIT\_FOR\_TRIGGER* state to the *MEASURING* state.

Normally this status change is always sent to the control unit. If measurement times are very short and/or trigger events occur at a high frequency, however, this may lead to a heavy load on the remote-control connection which cannot be handled by the control unit (or host). The *SUTime* parameter can be used to define how long the sensor may remain in the *WAIT\_FOR\_TRIGGER* state without the corresponding status message being output.

*SUTime* is usually set to a value that is slightly smaller than the response time of the control system. Trigger events that have not yet occurred can then still be detected in time. At high trigger frequencies, the result is that after the start of the measurement, only the first changeover to the *WAIT\_FOR\_TRIGGER* state and the subsequent changeover to the *MEASURING* state are reported. The next message would not come until the transition to the *IDLE* state following the completion of the measurement.

**Default setting:** 0.0001 [s]

### **SYSTEM:TRANsaction:BEgIn**

*SYSTEM:TRANsaction:BEgIn* marks the beginning of a sequence of setting commands between which the parameter limits must not be checked. This prevents the display of error messages when a setting command causes a conflict that is resolved by a subsequent setting command. See *SYSTEM:TRANsaction:END*.

### **SYSTEM:TRANsaction:END**

*SYSTEM:TRANsaction:END* marks the end of a sequence of setting commands between which the parameter limits must not be checked. After this command, the parameter limits are checked.

**TEST**Table 6-6 Commands of the *TEST* system

Command	Parameter	Unit	Remarks
TEST:SENSor?			Query only

**TEST:SENSor?**

*TEST:SENSor?* triggers a selftest of the sensor. In contrast to *\*TST*, this command yields detailed information, which is useful for troubleshooting.



*No signal may be applied to the sensor while the selftest is running.*

*If the selftest is carried out with a signal being present, error messages may erroneously be output for the test steps "Offset Voltages" and/or "Noise Voltages".*

## TRIGger

Table 6-7 Commands of the TRIGger system

Command	Parameter	Unit	Remarks
ABORt			No query
INITiate			
:CONTInuous[?]	OFF   ON		
:IMMediate			No query
TRIGger			
:ATRigger:STATe[?]	OFF   ON		
:COUNt[?]	1 to 2 <sup>31</sup>		
:DELay[?]	x to 100.0	s	
:AUTO[?]	OFF   ON		
:HOLDoff[?]	0.0 to 10.0	s	
:HYSTeresis[?]	0.0 to 10.0	dB	
:IMMediate			No query
:LEVel[?]	x to y	W	
:SLOPe[?]	POSitive   NEGative		
:SOURce[?]	BUS   EXTernal   HOLD   IMMediate   INTernal		

### ABORt

*ABORt* interrupts the current measurement and sets the sensor to the *IDLE* state (normal case). However, if the sensor is in the continuous measurement mode (setting *INITiate:CONTInuous ON*), the *IDLE* state is immediately exited and the sensor enters the *WAIT\_FOR\_TRIGGER* state.

### INITiate:CONTInuous[?] OFF | ON

*INITiate:CONTInuous ON* activates the continuous measurement mode. In this mode, a new measurement cycle is automatically started after the previous one has been terminated. The sensor first enters the *WAIT\_FOR\_TRIGGER* state and begins with the measurement as soon as the trigger condition is fulfilled. Depending on the number of trigger events that are required for the final measurement result, e.g. in the case of averaging, the *WAIT\_FOR\_TRIGGER* state can be entered several times before a measurement result is output. Once the entire measurement cycle is completed, the sensor also enters the *WAIT\_FOR\_TRIGGER* state and – assuming continuous trigger events – will continue measuring.

If the continuous measurement mode is switched off by means of the *INITiate:CONTInuous OFF* command, single measurements can be started with the *INITiate:IMMediate* command (see below).



After triggering and completion of the measurement, the sensor enters the *IDLE* state and remains in this state until a new measurement is started with the *INITiate:IMMEDIATE* command.

The query yields

- 1 for *OFF*,
- 2 for *ON*.

**Default setting:** *OFF*

## INITiate:IMMEDIATE

*INITiate:IMMEDIATE* starts a single measurement cycle. The sensor first changes from the *IDLE* state to the *WAIT\_FOR\_TRIGGER* state and begins the measurement as soon as the trigger condition is fulfilled. Depending on the number of trigger events that are required, e.g. for averaging, the *WAIT\_FOR\_TRIGGER* state can be entered several times. Once the entire measurement is completed, a measurement result is available and the sensor enters the *IDLE* state again. The *INITiate:IMMEDIATE* command should only be used after the continuous measurement mode has been switched off with the *INITiate:CONTinuous OFF* command.

## TRIGger:ATRigger:STATE[?] OFF | ON

*TRIGger:ATRigger:STATE ON* generates an artificial trigger if more than 300 ms have elapsed after the start of measurement and no trigger event has been recorded. The command is only evaluated in the *Trace* mode and, irrespective of the set averaging factor, only one trace will be recorded. *TRIGger:ATRigger:STATE OFF* deactivates the automatic trigger function.

The query yields

- 1 for *OFF*,
- 2 for *ON*.

**Default setting:** *OFF*

## TRIGger:COUNT[?] 1 to 2<sup>31</sup>

This setting is designed for applications in which several consecutive measurements have to be performed by sending the *INITiate:IMMEDIATE* command only once, e.g. to obtain a higher measurement speed. The gap between a single measurement and the continuous measurement mode is thus closed. The number of measurements is defined with the parameter associated with the *TRIGger:COUNT* command. This number equals the number of results yielded by the sensor at the end of the measurement. A measurement result can contain several numeric results, e.g. power values for the points of a trace.



*The TRIGger:COUNT command does not define the number of trigger events required for performing the entire measurement task. The number is either identical or a whole-number multiple, if averaging was activated.*

*A further increase in the measurement speed can be obtained by combining the mode used with the buffered mode. The results are not made available immediately but as a block at the end of the measurement sequence (see group commands *SENSe:POWer:AVG:BUFFer*).*

The query yields the number of measurements performed with the *INIT:IMMEDIATE* command after a measurement start.

**Default setting:** 1

**TRIGger:DElay[?] x to 100.0**

This command is used to set a trigger delay for all measurements in sync with the signal except in the *Burst Average* mode. It provides a time offset to the physical trigger event equal to the entered value. The trigger can thus be shifted to a point in time of the measurement signal that is significant for the measurement, for example to the start of the first timeslot for the *Timeslot Average* mode. If external triggering is used, delay differences between the external trigger signal and the measurement signal can be compensated for with a trigger delay.

It is possible to set negative trigger delays, i.e. the trigger point can occur before the physical trigger event. No matter which measurement mode is selected, the negative limit is  $-5$  ms. If the trigger delay is entered in the *Trace* mode, an additional condition must be met: The sum of the start of recording and the trigger delay must not exceed the length of  $-5$  ms (see notes on the *SENSe:TRACe:OFFSet:TIME* command). If full use is made of this value, the order in which the trigger delay and the start of recording are entered determines whether a trigger delay down to  $-5$  ms can be set. When a different measurement mode is selected, the full  $-5$  ms become immediately available again. When switching (back) to the *Trace* mode, the trigger delay that has been set is retained and, if there is a conflict, the start of recording is adjusted automatically.

The time resolution of the trigger delay is approx.  $7 \mu\text{s}$  with internal triggering and approx.  $1 \mu\text{s}$  with external triggering.

Any trigger delay that is set comes into effect irrespective of the defined trigger source, but this is only useful with the *Internal* und *External* settings.

**Lower limit x of the parameter**

*Timeslot Average* mode:  $x = -0.005$

*Trace* mode:  $x = -(<SENSe:TRACe:OFFSet:TIME> + 0.005)$

**Default setting:**  $0.0$  [s]

**TRIGger:DElay:AUTO[?] OFF | ON**

*TRIGger:DElay:AUTO ON* ensures by means of an automatically determined delay that a measurement is only started after the sensor has settled. This is relevant mainly for thermal power sensors (negligible for the R&S NRP-Z11/21/31/41/61/211/221). If the automatic trigger delay was activated with the *TRIGger:DElay:AUTO ON* command, it has the following effect:

After exiting the *WAIT\_FOR\_TRIGGER* state – initiated by the trigger event – the first analog-digital conversion is not performed until the settling time of the sensor has elapsed once. If the measurement cycle has to be repeated due to an averaging factor other than one, no further delay occurs.

The automatically determined delay is ignored if a longer period was set with *TRIGger:DElay*.

*TRIGger:DElay:AUTO OFF* deactivates the automatic trigger delay.

The query yields

- 1 for *OFF*,
- 2 for *ON*.

**Default setting:** *OFF*

**TRIGger:HOLDoff[?] 0.0 to 10.0**

*TRIGger:HOLDoff* suppresses trigger events within the set holdoff time (in s), starting from the time of the last successful triggering.

The query yields the set holdoff time (in s).

**Default setting:**  $0.0$  [s]

**TRIGger:HYSTeresis[?] 0.0 to 10.0**

*TRIGger:HYSTeresis* sets the hysteresis of the internal trigger threshold (parameter *TRIGger:LEVel*). Hysteresis is the magnitude (in dB) by which the trigger signal level falls below the trigger threshold (with positive trigger edge) to enable triggering again. The case is exactly the opposite with a negative trigger edge. The trigger hysteresis setting is only relevant to the *INTernal* trigger source.

The query yields the trigger hysteresis in dB.

**Default setting:** 0.0 [dB]

**TRIGger:IMMediate**

*TRIGger:IMMediate* triggers a generic trigger event that causes the power sensor to exit immediately the *WAIT\_FOR\_TRIGGER* state irrespective of the trigger source and the trigger delay and begin with the measurement. The command is the only means of starting a measurement when the trigger source is set to *HOLD*. Only one measurement cycle is performed, irrespective of the set averaging factor.

**TRIGger:LEVel[?] x to y**

*TRIGger:LEVel* sets the trigger threshold for internal triggering derived from the test signal (in W). This setting is irrelevant to all other trigger sources. If an s-parameter device is active and/or if a component with a global offset upstream from the sensor is considered, the currently effective trigger threshold as well as a trigger threshold to be input are referenced to the appropriately shifted sensor interface. When the s-parameter device and the offset correction are switched off, then the trigger threshold and its input limits are adjusted as necessary.

The query yields the currently effective trigger threshold in W.

**Lower limit x and upper limit y of the trigger threshold**

*SENSe:CORRection:OFFSet:STATe OFF:*

$x = \text{<lower test limit in W>} \times 500$

$y = \text{<upper test limit in W>}$

*SENSe:CORRection:OFFSet:STATe ON:*

$x = \text{<lower test limit in W>} \times 500 \times 10^{\text{OFFSET} / 10 \text{ dB}}$

$y = \text{<upper test limit in W>} \times 10^{\text{OFFSET} / 10 \text{ dB}}$

<lower test limit in W>: The nominal lower test limit of the sensor or of the twoport/sensor combination (with activated s-parameter correction)

<upper test limit in W>: The nominal upper test limit of the sensor or of the twoport/sensor combination (with activated s-parameter correction)

The nominal test limits can be read out with the *SYSTem:INFO? "MINPOWER"* and *SYSTem:INFO? "MAXPOWER"* command.

**Default setting:**  $10 \times x$

**TRIGger:SLOPe[?] POSitive | NEGative**

*TRIGger:SLOPe* defines the edge of the trigger event with internal and external triggering in the *Continuous Average*, *Timeslot Average*, and *Trace* modes. In this connection, positive means increasing envelope power (with internal triggering) or increasing voltage (with external triggering). As in the *Burst Average* mode, this command has no effect in conjunction with trigger sources *BUS*, *HOLD* and *IMMediate*.

The query yields

- 1 for *POSitive*,
- 2 for *NEGative*.

**Default setting:** *POSitive*

## **TRIGger:SOURce[?] HOLD | IMMEDIATE | INTERNAL | BUS | EXTERNAL |**

*TRIGger:SOURce* sets the trigger source.

- *HOLD*: Triggering only with command *TRIGger:IMMEDIATE*.
- *IMMEDIATE*: Automatic triggering without explicit event.
- *INTERNAL*: Triggering by the measurement signal. Relevant parameters: *TRIGger:LEVel*, *TRIGger:SLOPe*, *TRIGger:DELay*, *TRIGger:HYSteresis*, *TRIGger:HOLDoff*.
- *BUS*: Triggering with command *\*TRG* or *TRIGger:IMMEDIATE*.
- *EXTERNAL*: Triggering via the hardware trigger bus, e.g. via the R&S NRP-Z5 sensor hub or the R&S NRP2 base unit. Relevant parameters: *TRIGger:SLOPe*, *TRIGger:DELay*, *TRIGger:HOLDoff*.

The query yields

- 1 for *HOLD*,
- 2 for *IMMEDIATE*,
- 4 for *INTERNAL*,
- 8 for *BUS*,
- 16 for *EXTERNAL*.

**Default setting:** *IMMEDIATE*

## List of Remote-Control Commands

The remote-control commands of the R&S NRP-Z11/21/31/41/61/211/221 have a syntax based on standard SCPI 1999.0, but they comply with it only to a limited extent.

Table 6-8 List of remote-control commands

Command	Parameter	Unit	Default setting	Page
<b>* Commands</b>				
*IDN?				6.2
*RST				6.2
*TRG				6.2
*TST?				6.2
<b>CALibration Commands</b>				
CALibration:DATA[?]	<calibration data set as definite length block>			6.3
CALibration:DATA:LENGth?		Bytes		6.3
CALibration:ZERO:AUTO[?]	OFF   ON   ONCE		OFF (fixed)	6.3
<b>SENSe Commands</b>				
SENSe:AVERage:COUNT[?]	1 to 65536		4	6.7
SENSe:AVERage:COUNT:AUTO[?]	OFF   ON   ONCE		ON	6.7
SENSe:AVERage:COUNT:AUTO:MTIME[?]	0.01 to 999.99	s	4.0	6.7
SENSe:AVERage:COUNT:AUTO:NSRatio[?]	0.0 to 1.0	dB	0.01	6.8
SENSe:AVERage:COUNT:AUTO:RESolution[?]	1 to 4		3	6.8
SENSe:AVERage:COUNT:AUTO:SLOT[?]	1 to <SENSe:POWer:TSLot:AVG:COUNT>		1	6.8
SENSe:AVERage:COUNT:AUTO:TYPE[?]	RESolution   NSRatio		RESolution	6.8
SENSe:AVERage:RESet				6.9
SENSe:AVERage:STATe[?]	OFF   ON		ON	6.9
SENSe:AVERage:TCONtrol[?]	MOVing   REPeat		REPeat	6.9
SENSe:CORRection:DCYCLE[?]	0.001 to 99.999	%	1.0	6.9
SENSe:CORRection:DCYCLE:STATe[?]	OFF   ON		OFF	6.10
SENSe:CORRection:OFFSet[?]	-200.0 to 200.0	dB	0.0	6.10

Command	Parameter	Unit	Default setting	Page
SENSe:CORRection:OFFSet:STATe[?]	OFF   ON		OFF	6.10
SENSe:CORRection:SPDevice:STATe[?]	OFF   ON		OFF (can be modified by the user)	6.10
SENSe:FREQuency[?]	10.0e6 to 8.0e9 (NRP-Z11/211) or 10.0e6 to 18.0e9 (NRP-Z21/221) or 10.0e6 to 33.0e9 (NRP-Z31) or 10.0e6 to 40.0e9 (NRP-Z41) or 10.0e6 to 50.0e9 (NRP-Z61)	Hz	50.0e6	6.11
SENSe:FUNcTION[?]	"POWer:AVG"   "POWer:TSLot:AVG"   "POWer:BURSt:AVG"   "XTIME:POWer"		"POWer:AVG"	6.11
SENSe:POWer:AVG:APERture[?]	10.0e-6 to 0.3	s	0.02	6.12
SENSe:POWer:AVG:BUFFer:SIZE[?]	1 to 1024		1	6.13
SENSe:POWer:AVG:BUFFer:STATe[?]	OFF   ON		OFF	6.13
SENSe:POWer:AVG:SMOothing:STATe[?]	OFF   ON		OFF	6.13
SENSe:POWer:BURSt:DTOLerance[?]	0.0 to 0.003	s	0.0001	6.14
SENSe:POWer:TSLot:AVG:COUNt[?]	1 to 128		8	6.14
SENSe:POWer:TSLot:AVG:WIDTh[?]	10.0e-6 to 0.1	s	0.001	6.14
SENSe:RANGe[?]	0 to 2 (NRP-Z11/21/31/41/61) or 0 to 1 (NRP-Z211/221)		2 (NRP-Z11/21/31/41/61) 1 (NRP-Z211/221)	6.15
SENSe:RANGe:AUTO[?]	OFF   ON		ON	6.15
SENSe:RANGe:CLEVel[?]	-20.0 to 0.0	dB	0.0	6.15
SENSe:SAMPLING[?]	FREQ1   FREQ2		FREQ1	6.15
SENSe:SGAMma:CORRection:STATe[?]	OFF   ON		OFF	6.16
SENSe:SGAMma:MAGNitude[?]	0.0 to 1.0		0.0	6.17
SENSe:SGAMma:PHASe[?]	-360.0 to 360.0	degree	0.0	6.17
SENSe:TIMing:EXCLude:STARt[?]	0.0 to 0.1	s	0.0	6.17
SENSe:TIMing:EXCLude:STOP[?]	0.0 to 0.003	s	0.0	6.17
SENSe:TRACe:AVERAge:COUNt[?]	1 to 8192		4	6.17
SENSe:TRACe:AVERAge:STATe[?]	OFF   ON		ON	6.19
SENSe:TRACe:AVERAge:TCONtrol[?]	MOVing   REPeat		REPeat	6.19
SENSe:TRACe:MPWidth?		s		6.19

Command	Parameter	Unit	Default setting	Page
SENSe:TRACe:OFFSet:TIME[?]	– (<TRIGger:DELay> + 0.005) to 100.0	s	0.0	6.19
SENSe:TRACe:POINts[?]	1 to 1024		100	6.20
SENSe:TRACe:REALtime[?]	OFF   ON		OFF	6.20
SENSe:TRACe:TIME[?]	0.0001 to 0.3	s	0.01	6.20
<b>SYSTem Commands</b>				
SYSTem:INFO? [Item]				6.21
SYSTem:INITialize				6.23
SYSTem:MINPower?		W		6.23
SYSTem:RUTime	0.0 ... 10.0	s	0.1	6.23
SYSTem:SUTime	0.0 ... 10.0	s	0.0001	6.24
SYSTem:TRANsaction:BEgin				6.23
SYSTem:TRANsaction:END				6.24
<b>Test Commands</b>				
TEST:SENSor?				6.25
<b>Triggersystem Commands</b>				
ABORt				6.26
INITiate:CONTinuous[?]	OFF   ON		OFF	6.26
INITiate:IMMediate				6.27
TRIGger:ATRigger:STATe[?]	OFF   ON		OFF	6.27
TRIGger:COUNt[?]	1 to 2 <sup>31</sup>		1	6.27
TRIGger:DELay[?]	x to 100.0	s	0.0	6.28
TRIGger:DELay:AUTO[?]	OFF   ON		OFF	6.28
TRIGger:HOLDoff[?]	0.0 to 10.0	s	0.0	6.28
TRIGger:HYSTeresis[?]	0.0 to 10.0	dB	0.0	6.29
TRIGger:IMMediate				6.29
TRIGger:LEVel[?]	x to y	W	10 × x	6.29
TRIGger:SLOPe[?]	POSitive   NEGative		POSitive	6.29

<b>Command</b>	<b>Parameter</b>	<b>Unit</b>	<b>Default setting</b>	<b>Page</b>
TRIGger:SOURce[?]	HOLD   IMMEDIATE   INTERNAL   BUS   EXTERNAL		IMMEDIATE	6.30